

User Manual

p

Real-Time Wander Analyst Software

CTS 850 for SDH

CTS 850 for E1, E2, E3, E4

SJ300E for SDH/SONET

071-0518-00

This document applies to firmware version 6.0 and above.

Copyright © 1998 Tektronix, Inc. All rights reserved. Licensed software products are owned by Tektronix or its suppliers and are protected by United States copyright laws and international treaty provisions.

Use, duplication, or disclosure by the Government is subject to restrictions as set forth in subparagraph (c)(1)(ii) of the Rights in Technical Data and Computer Software clause at DFARS 252.227-7013, or subparagraphs (c)(1) and (2) of the Commercial Computer Software - Restricted Rights clause at FAR 52.227-19, as applicable.

Tektronix products are covered by U.S. and foreign patents, issued and pending. Information in this publication supersedes that in all previously published material. Specifications and price change privileges reserved.

Printed in the U.S.A.

Tektronix, Inc., P.O. Box 1000, Wilsonville, OR 97070-1000

TEKTRONIX and TEK are registered trademarks of Tektronix, Inc.

LabView is a registered trademark of National Instrument, Inc.

WARRANTY

Tektronix warrants that this product will be free from defects in materials and workmanship for a period of one (1) year from the date of shipment. If any such product proves defective during this warranty period, Tektronix, at its option, either will repair the defective product without charge for parts and labor, or will provide a replacement in exchange for the defective product.

In order to obtain service under this warranty, Customer must notify Tektronix of the defect before the expiration of the warranty period and make suitable arrangements for the performance of service. Customer shall be responsible for packaging and shipping the defective product to the service center designated by Tektronix, with shipping charges prepaid. Tektronix shall pay for the return of the product to Customer if the shipment is to a location within the country in which Tektronix service center is located. Customer shall be responsible for paying all shipping charges, duties, taxes, and any other charges for products returned to any other locations.

This warranty shall not apply to any defect, failure or damage caused by improper use or improper or inadequate maintenance and care. Tektronix shall not be obligated to furnish service under warranty a) to repair damage resulting from attempts by personnel other than Tektronix representatives to install, repair or service the product; b) to repair damage resulting from improper user or connection to incompatible equipment; or c) to service a product that has been modified or integrated with other products when the effect of such modification or integration increases the time or difficulty of servicing the product.

THIS WARRANTY IS GIVEN BY TEKTRONIX WITH RESPECT TO THIS PRODUCT IN LIEU OF ANY OTHER WARRANTIES, EXPRESSED OR IMPLIED. TEKTRONIX AND ITS VENDORS DISCLAIM ANY IMPLIED WARRANTIES OF MERCHANTABILITY OR FITNESS FOR A PARTICULAR PURPOSE. TEKTRONIX' RESPONSIBILITY TO REPAIR OR REPLACE DEFECTIVE PRODUCTS IS THE SOLE AND EXCLUSIVE REMEDY PROVIDED TO THE CUSTOMER FOR BREACH OF THIS WARRANTY. TEKTRONIX AND ITS VENDORS WILL NOT BE LIABLE FOR ANY INDIRECT, SPECIAL, INCIDENTAL, OR CONSEQUENTIAL DAMAGES IRRESPECTIVE OF WHETHER TEKTRONIX OR THE VENDOR HAS ADVANCE NOTICE OF THE POSSIBILITY OF SUCH DAMAGES.

License Agreement and Warranty Information

TEKTRONIX SOFTWARE LICENSE AGREEMENT

The enclosed program is furnished subject to the terms and conditions of this agreement, retention of the program for more than thirty days, opening the sealed wrapper, if any, surrounding the program or use of the program in any manner will be considered acceptance of the agreement terms. If these terms are not acceptable, the unused program and any accompanying documentation should be returned promptly to Tektronix, inc. For a full refund of the license fee paid.

DEFINITIONS:

"Program" means the Tektronix software product (executable program and/or data) enclosed with this Agreement or included within the equipment with which this Agreement is packed.

"Customer" means the person or organization in whose name the Program was ordered.

LICENSE.

The Customer may:

- a) Use the Program under a nontransferable license on a single specified machine
- b) Copy the Program for archival or backup purposes, provided that no more than one (1) such copy is permitted to exist at any one time. Each copy of the Program made by Customer must include a reproduction of any copyright notice or restrictive rights legend appearing in or on the copy of the Program as received from Tektronix.

The Customer may not:

- a) Transfer the Program to any person or organization outside of Customer or the corporation of which Customer is a part without the prior written consent of Tektronix.
- b) Export or re-export, directly or indirectly, the program, any associated documentation, or the direct product thereof, to any country to which such export or re-export is restricted by law or regulation of the United States or any foreign government having jurisdiction without the prior authorization, if required, of the Office of Export Administration, Department of Commerce, Washington, D.C. and the corresponding agency of such foreign government.
- c) For object-code Programs only, reverse compile or disassemble the Program for any purpose; or
- d) Copy the documentation accompanying the Program.

For Programs designed to reside on a single-machine and support one or more additional machines, either locally or remotely, without permitting the Program to be transferred to an additional machine for local execution, the additional

machines shall be considered within the definition of "single machine". For programs permitting the Program to be transferred to an additional machine for local execution, a separate license shall be required for each such machine with which the Program may be used.

Title to the Program and all copies thereof, but not the media on which the Program or copies may reside shall be and remain with Tektronix.

Customer shall pay when due all property taxes that may now or hereafter be imposed, levied or assessed with respect to the possession or use of the Program or this license and shall file all reports required in connection with such taxes.

Any portion of the Program modified by Customer or merged with another program shall remain subject to these terms and conditions.

If the Program is acquired by or for an agency of the U.S. Government, the Program shall be considered computer software developed at private expense and the license granted herein shall be interpreted as granting Customer restricted rights in the Program and related documentation as defined in the applicable acquisition regulation.

THE PROGRAM MAY NOT BE USED, COPIED, MODIFIED, MERGED, OR TRANSFERRED TO ANOTHER EXCEPT AS EXPRESSLY PERMITTED BY THESE TERMS AND CONDITIONS.

UPON TRANSFER OF ANY COPY, MODIFICATION, OR MERGED PORTION OF THE PROGRAM, THE LICENSE GRANTED HEREIN IS AUTOMATICALLY TERMINATED.

TERM. The license granted herein is effective upon acceptance by Customer, and shall remain in effect until terminated as provided herein. The License may be terminated by Customer at any time upon written notice to Tektronix. The license may be terminated by Tektronix or any third party from whom Tektronix may have obtained a respective licensing right if Customer fails to comply with any term or condition and such failure is not remedied within thirty (30) days after notice thereof from Tektronix or such third party. Upon termination by either party, Customer shall return to Tektronix, the Program and all associated documentation, together with all copies in any form.

LIMITED WARRANTY. Tektronix warrants that the media on which the Program is furnished and the encoding of the Program on the media will be free from defects in materials and workmanship for a period of three (3) months from the date of shipment. If any such medium or encoding proves defective during the warranty period, Tektronix will provide a replacement in exchange for the defective medium. Except as to the media on which the Program is furnished, the Program is provided "as is" without warranty of any kind, either express or implied. Tektronix does not warrant that the functions contained in the Program will meet Customer's requirements or that the operation of the Program will be uninterrupted or error-free.

In order to obtain service under this warranty, Customer must notify Tektronix of the defect before the expiration of the warranty period. If Tektronix is unable to

provide a replacement that is free from defects in materials and workmanship within a reasonable time thereafter, Customer may terminate the license for the Program and return the Program and any associated materials for credit or refund.

This warranty is given by Tektronix with respect to the program in lieu of any other warranties, express or implied. Tektronix and its vendors disclaim any implied warranties of merchantability or fitness for a particular purpose., Tektronix's responsibility to replace defective media, or refund customer's payment is the sole and exclusive remedy provided to the customer for breach of this warranty.

Limitation of liability, in no event shall Tektronix or others from whom Tektronix has obtained a licensing right be liable for any indirect, special, incidental, or consequential damages arising out of or connected with customer's possession or use of the program, even if Tektronix or such others has advance notice of the possibility of such damages.

THIRD-PARTY DISCLAIMER. Except as expressly agreed otherwise, third parties from whom Tektronix may have obtained a licensing right do not warrant the program, do not assume any liability with respect to its use, and do not undertake to furnish any support or information relating thereto.

GENERAL. This Agreement contains the entire agreement between the parties with respect to the use, reproduction, and transfer of the Program.

Neither this Agreement nor the license granted herein is assignable or transferable by Customer without the prior written consent of Tektronix.

This Agreement and the license granted herein shall be governed in the United States by the laws of the State of Delaware.

All questions regarding this Agreement or the license granted herein should be directed in the United States to the nearest Tektronix Sales Office.

How to Reach Customer Service

If you have any questions regarding the operation, maintenance, repair, or application of your Tektronix equipment, contact your local sales and service office. This unit should be calibrated yearly. For a complete list of Worldwide Sales and Service Offices, contact (800) 426-2200 or see the table below for other methods of contacting Tektronix sales and service.

Tektronix provides high quality Technical Support on applications, operation, measurement specifications, hardware, and software by expert application engineers. For Applications Support, call the Customer Support Center listed below.

Mailing Address	Tektronix, Inc. Measurement Business Division P.O. Box 500 Beaverton, Oregon 97077-0001 USA	Attn. Customer Service
Customer and Sales Support Center	800-TEK-WIDE or 800-835-9433 Ext 2400	Hours are 6:00 AM to 5:00 PM, Pacific Time. After hours Voice Mail is available.
Direct	503-627-2400	
Fax	503-627-5695	
E-Mail	tm_app_supp@tek.com	
Web Site	http://www.tek.com	

**U.S.A., Africa, Asia, Australia, Central & South America,
Japan**

Tektronix, Inc.
P.O. Box 500
Beaverton, Oregon 97077-0001
For additional literature, or the address and phone number of the
Tektronix Sales Office or Representative nearest you, contact: (800)
426-2200

Belgium: Brussels
Phone: 32(2) 725 96 10
Fax: 32(2) 725 99 53

Canada: Calgary
Phone: (403) 274-2691
Fax: (403) 274-3483

Denmark: Copenhagen
Phone: 45 44 850 700
Fax: 45 44 850 701

Eastern Europe, Middle East and Austria
Tektronix Ges.m.b.H
Triester Strasse 14
A-2351 Wiener Neudorf, Austria
Phone: ++43 (2236) 8092-0
Fax: ++43 (2236) 8092-200

Finland: Helsinki
Phone: 358 4783 400
Fax: 358 47834 200

France and North Africa
Tektronix S.A.
ZAC Courtaboeuf, 4 Av du Canada
B.P.13
91941 Les Ulis Cedex, France
Phone: 33(1) 69 86 81 81
Fax: 33(1) 69 07 09 37

Germany: Cologne
Phone: 49(221) 94770
Fax: 49(221) 9477 200

Italy: Milan
Phone: 39(2) 25 0861
Fax: 39(2) 25 086 400

Japan: Tokyo
Phone: 81(3) 3448-3111
Fax: 81(3) 3444-3661

The Netherlands: Hoofddorp
Phone: 31(23) 069 5555
Fax: 31(23) 569 5500

Norway: Oslo
Phone: 47(22) 07 0700
Fax: 47(22) 07 0707

Spain: Madrid
Phone: 34(1) 372 6000
Fax: 34(1) 372 6049

Sweden: Stockholm
Phone: 46(8) 629 6500
Fax: 46(8) 629 6540

Tektronix sales and service offices around the
world:
Algeria,
Argentina, Australia,
Bahrain, Bangladesh, Belgium,
Bolivia,
Brazil,
Bulgaria,
Canada,
Chile,
People's Republic
of China, Columbia,
Costa Rica, Cypress, Czechoslovakia, Denmark,
Ecuador,
Egypt,
Finland,
France,
Germany,
Greece,
Hong Kong, Iceland,
India,
Indonesia,
Ireland,
Israel,
Italy,
Ivory Coast,
Japan,
Jordan,
Korea,
Kuwait,
Lebanon, Malaysia,
Mexico,
The Netherlands, New Zealand, Nigeria,
Norway,
Oman,
Pakistan,
Panama,
Peru,
Phillippines, Poland,
Portugal,
Saudi Arabia, South Africa, Singapore,
Spain,
Sri Lanka,
Sweden, Switzerland, Taiwan,
Thailand,
Tunisia,
Turkey,
United Arab Emirates,
United Kingdom,
Uruguay,
Venezuela,
Zimbabwe

Switzerland: Zug
Phone: 41(42) 219192
Fax: 41(42) 217784

U.K.: Marlow
Phone: 44 1628 403300
Fax: 44 1628 403301

Table Of Contents

License Warranty.....	iv
Customer Service, how to reach	vii
Getting Started	1-1
Wander Analyst Software	1-2
Program Overview	1-2
Changes from Previous Versions	1-4
Specifications	1-4
SDH/SONET Analyzer Hardware Requirements	1-6
Personal Computer Hardware Requirements	1-6
Operating Basics	1-7
Software Installation	1-7
Distribution Diskette Contents	1-7
Installation Procedure	1-7
Program Configuration.....	1-8
Port Configuration.....	1-8
RS-232 Port Setup	1-8
GPIB Port Setup	1-8
Program Startup.....	1-9
Wander Analyst Program Startup.....	1-9
Program First Start	1-10
File Selection.....	1-11
Communication Selection.....	1-12
Uploading Data Setup	1-13
Upload Configuration Menu.....	1-13
Uploading Data from the test set	1-14
Graphic Displays.....	1-15
Plot Menu.....	1-16
Mask Menu	1-18
Process Data Menu	1-22
Help Selection	1-23
Keyboard Operation without a Mouse.....	1-24
Zoom, In, Zoom Out, Full.....	1-24

Reference	2-1
Wander Test Functions	2-2
Generate Wander and Jitter References	2-2
Measuring DS1 Wander Relative to a Reference.....	2-3
Measuring SONET/SDH Wander Relative to a Reference	2-3
Calculate TDEV.....	2-3
Calculate MTIE	2-3
Applications	2-4
Basic Wander Measurement	2-4
Synchronization Setup.....	2-4
Measurement Selection	2-4
Wander measurements displayed on the Test Set.....	2-5
Generating Phase Transients	2-6
Specification for Transient Generation.....	2-6
Phase Transient Generation Procedure.....	2-7
Phase Transient Conformance Testing.....	2-8
OC-N Phase Transient Test.....	2-8
Synchronization Clock Transient Test.....	2-10
Wander Transfer Conformance Testing.....	2-12
Wander Transfer Specifications.....	2-12
Transfer from DS1 to OC-N.....	2-12
Transfer from OC-N to OC-N.....	2-13
Jitter & Wander Technical Articles.....	2-16
New issues in Timing and Synchronization	2-17
Video Transport in Broadband Networks	2-17
Consequences of Jitter & Wander in the Network.....	2-18
Testing for Jitter and Wander.....	2-19
Principles & Metrics of Jitter and Wander.....	2-32
Wander Masks (Version 6.0).....	A-1
TDEV and MTIE (SONET standards) (Version 5.0)	B-1
TDEV and MTIE (SDH standards) (Version 5.0).....	C-1
Index	Index-1

Preface

This manual describes how to use the Real-Time Wander Analyst software. This manual is intended for telecommunications engineers and technicians with more than two years experience with SONET or SDH networks.

This manual supports the Real-Time Wander Analyst software, version 6.0.

The diskette(s) containing this software are available as Tektronix part number 063-3196-00.

How this Manual is Organized

The document covers the Real-Time Wander Analyst software and applications. The complete analytical system includes:

- The Real-Time Wander Analyst software program
- SDH/SONET Analyzer with the Wander Test Option
- Computer Software and Hardware

The manual is divided into three sections: *Getting Started*, *Reference*, and *Appendices*.

Getting Started discusses the hardware requirements for either the CTS 850 SDH Generator/Analyzer with Option 14 - Jitter Generator/Analyzer, or the SJ300E SONET/SDH Jitter and Wander Analyzer and your Personal Computer (PC). It details the installation and configuration of the complete.

This chapter provides all of the basic information needed to begin using the Real-Time Wander Analyst system.

Reference details the theory, functions, and applications of Jitter, Wander, and Phase Transient measurement. It includes the definitions and specifications. This chapter also includes two technical articles explaining Jitter & Wander

The *Appendices* detail the following:

- Appendix A: Wander Masks (Version 6.0)
- Appendix B: Time Deviation (TDEV) and Maximum Time Interval Error (MTIE) standards for the North American Continent (Version 5.0);
- Appendix C: Time Deviation (TDEV) and Maximum Time Interval Error (MTIE) standards for the STM and the 2.048 Mb/s Hierarchy (Version 5.0)

Conventions

The manual uses the following conventions:

- TIE is an acronym for the words: Time Interval Error.
- TDEV is acronym for the words: Time Deviation.
- MTIE is an acronym for the words: Maximum Time Interval Error.

Related Manuals

In addition to this manual, you may need a copy of the:

- CTS 850 Test Set, SDH/PDH, Jitter & Wander User Manual
Tektronix part number 070-9988-01, *or*
- SJ300E SONET/SDH Jitter and Wander Analyzer User's Guide,
Issue 1.0 July 1995 or later.

Getting Started

This chapter provides an overview of the Real-Time Wander Analyst software. It describes the hardware and software requirements; the system and software installation and configuration; and, the menu screens.

Real-Time Wander Analyst Software

Program Overview

Real-Time Wander Analyst software works in conjunction with the Tektronix CTS 850 or SJ300E test sets. The software provides full wander TIE, MTIE and TDEV analysis according to the most recent ITU-T, ETSI, ANSI and Bellcore standards.

The Windows-compatible PC software uploads TIE wander measurement data from the test set at a sampling rate of 50 Hz (in accordance with ITU-T and ETSI requirements), stores the data at a rate of 50, 1 or 0.1 Hz (selectable), and simultaneously calculates MTIE and TDEV using efficient algorithms.

In addition to the ITU-T and European ETSI specifications, Real-Time Wander Analyst also includes a full suite of North American SONET and ANSI specification limits.

The software provides a hi/lo envelope TIE plot to show transients, full zoom control via cursors and calculates frequency offset and drift rate in accordance with ANSI-approved methodology.

The Real-Time Wander Analyst software is capable of the following:

- TIE, MTIE and TDEV wander analysis
- Calculation and display of frequency offset and drift rate from TIE data
- SDH and SONET compatible
- Windows 95 compatible
- Comprehensive support for new, revised and draft ITU-T, ETSI, ANSI and Bellcore wander specifications
- Automatic mask testing for easy conformance test documentation
- Interactive use for design verification and performance assessment
- Flexible TIE data acquisition and storage control
- Efficient algorithms for speedy calculation of MTIE and TDEV

The Real-Time Wander Analyst program is a user friendly software package that uploads, stores, and displays wander Time Interval Error (TIE) data over the specified interval of time. The Time Deviation (TDEV) and Maximum Time Interval Error (MTIE) is computed while TIE is uploading and displayed when the plot is selected. The program also computes frequency drift and offset.

Figure 1-1 illustrates the Real-Time Wander Analyst program display and user interface. The display is divided into the following three areas: Pull Down Menu Bar; X Y Plot Display; and Program Status and Control. The Zoom Control Keys: In, Out, and Full, operate the display.

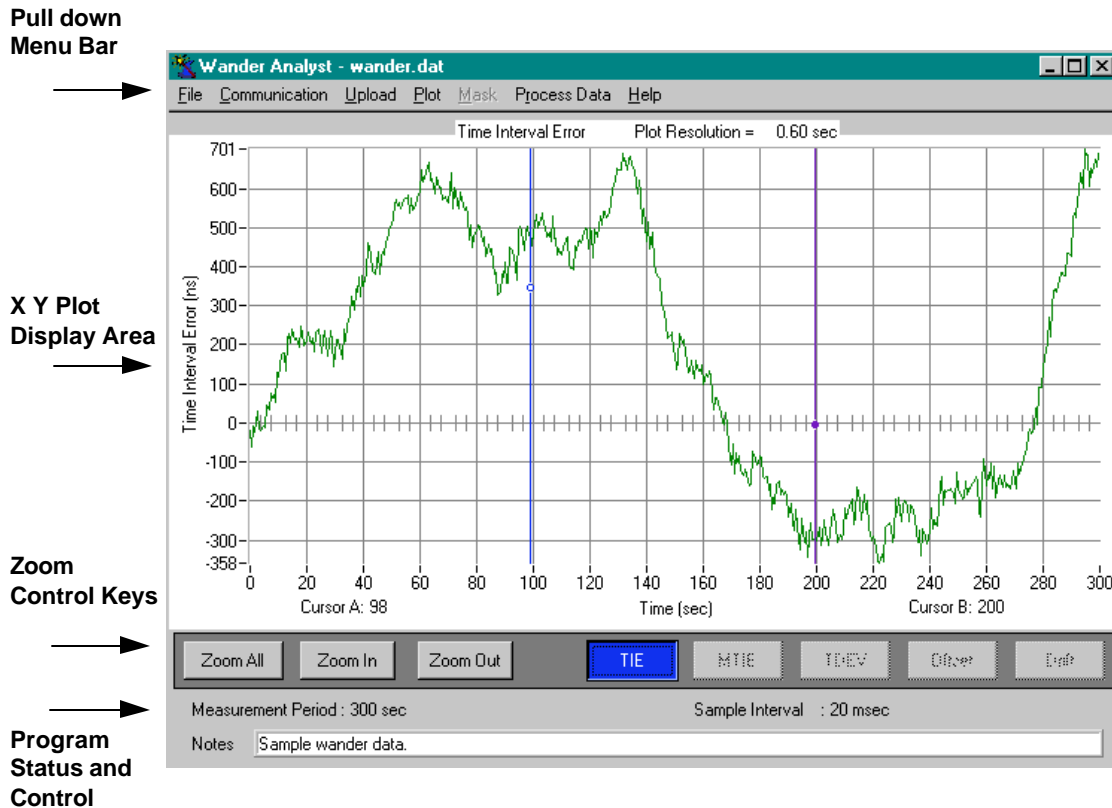

Figure 1-1. Wander Analyst Software Display and User Interface.

Version 6.0 of the Real-Time Wander Analyst software supports the CTS 850, in addition to the SJ300E. To support both systems, the Wander Analyst software, at the first time communications with a test set is established, will try to determine the type of device it is connected to.

When the program is started, or after the communications settings have changed, beginning a data upload will display a status screen indicating that the Wander Analyst software is auto-detecting the attached device (CTS 850 or SJ300E). Once detection is complete, the program proceeds in a normal fashion.

This auto-detection routine is also run whenever the user performs a communications test. If the attached unit is change from a CTS 850 to a SJ300E, differences in the remote interface will cause an upload failure unless the auto-detection procedure has run.

Changes from previous versions

In addition to more Mask selections, the 6.0 version adds a new menu selection on TIE, drift and offset graphs which permits changing of the graph cursor readout from raw seconds to a DD:HH:MM:SS format.

To increase the useable range for Wander Analyst, the format for TIE data storage has been changed to 8-bytes long. This has two effects:

- Data files take twice the disk space of prior versions.
- TIE data files from older versions can no longer be processed directly. Calculating TDEV, MTIE, drift and offset calculations from older versions of Wander Analyst will result in an error message. See the next paragraph for a way to utilize older information.

To perform calculations on TIE data captured and stored with an earlier version of Wander Analyst.

1. Open the .DAT file from the earlier version.
2. Save the file as ASCII (the same file name can be used).
3. Open the ASCII file. Even if the file name is re-used, the file/open command needs to be performed.
4. Save the file as binary. Again, the same name can be used.

Specifications

Conformance Tests

MTIE and/or TDEV SDH specific ation limit masks according to:

Primary Reference Clock

PRC, ITU-T G.811 and ETS 300 462-6

PRS, GR-2830 CORE

Wander generation

Slave Clocks

SSU, ITU-T G.812 Type I, ETS 300 462-4

Clock, ITU-T G.812 Type II, Type III

Clock, ITU-T G.812 Type IV

Clock, ITU-T G.812 Type V, Type VI

Clock, GR-1244-CORE

Wander generation; Wander tolerance; Noise transfer; Transient response

SDH/SONET Equipment Clock

SEC ITU-T G.813 Opt. 1, ETS 300 462-5

SEC ITU-T G.813 Opt. 2

SMC, GR-253-CORE

Wander generation; Wander tolerance; Noise transfer; Transient response;
Holdover response

Real-Time Wander Analyst Software

Test Set Requirements

CTS850 Opt. 14 or SJ300E Opt. 06 must be installed

Recommended PC Requirements

Processor: Pentium - 90 MHz or faster

Operating system: Windows 95

Memory: 16 MB minimum

Hard drive: 3.0 MB to load program, plus free space for data storage

TIE Data Acquisition and Storage

Using RS-232 or GPIB interfaces

50 Hz rate: 1.4 Mbyte/hour

1 Hz rate: 28.8 Kbyte/hour

0.1 Hz rate: 2.88 Kbyte/hour

Measurement duration: 1 to 9.9×10^5 sec

Software Processing Functions

MTIE and TDEV calculation: done during TIE data acquisition or post-acquisition

TIE display: sample or hi/lo envelope

Frequency offset and drift rate: in accordance with ANSI T1.101 over a fixed or sliding window with user-definable bandwidth

Remove frequency offset

Graph scaling: automatic or manual, with zoom, cursors

Documentation: print, clipboard copy

SDH/SONET Analyzer Hardware Requirements

CTS 850 - Option 14, Jitter & Wander Generator/Analyzer, must be installed in the CTS850. Option 38, must be installed for E1, E3, E4 Wander Testing. Option 04, 05, or 06 O/E modules must be installed for 622 Mbit/s Wander Testing. Software version 2.18 or higher in the CTS 850 required.

Either the RS-232C or the GPIB port, on the rear panel of the CTS 850, can be used to communicate with the PC. An RS-232C full-modem cable or a IEEE-488 GPIB cable that can interconnect the CTS 850 and the PC is also required, but not supplied with the option. To measure wander at line rates, use the regular connections on the front panel of the CTS 850.

SJ300E - The Wander Test Option must be factory installed in the SJ300E Jitter and Wander Analyzer. For the SJ300E, the option includes two BNC connectors on the rear panel of the SJ300E. One marked BITS/SETS IN and the other marked BITS/SETS OUT. Either the RS-232C or the GPIB port, already on the rear panel, will be used to communicate with the PC. An RS-232C full-modem cable or a IEEE-488 GPIB cable that can interconnect the SJ300E and the PC is also required, but not supplied with the option.

The SJ300E SONET/SDH Jitter and Wander Analyzer User's Guide details the use of the unit, its installation, initial checkout and setup procedures, local and remote functions.

Personal Computer Hardware Requirements

The program runs on an IBM compatible personal computer under the Windows 95 operating system.

The following hardware is required: a Pentium processor (90 MHz or faster), a minimum of 16 megabytes of RAM memory, a hard drive with 3.0 MB of available space to load the program and sufficient free space to store the collected data. A color monitor, such as a VGA, and mouse are recommended but not required.

The SJ300E and CTS 850 sample data at 50 samples per second. The Wander Analyst software can store all of those data points (data storage intervals = 20 msec) or it can store one point for every fifty samples by averaging the data points (data storage interval = 1 sec. The high and low values can be displayed graphically by selecting Plot, Display Mode, Hi/Low instead of Sample). The Storage Interval can also be 10 seconds.

When a twenty-four hour test is saved on the hard disk at fifty samples per second rate, it uses approximately 32-megabytes of hard drive storage space, and under one megabyte when stored at the one sample per second rate. A 72-hour test session at fifty samples per second will require almost 112-megabytes of disk storage space.

Operating Basics

This section provides all of the basic information needed to begin using the Real-Time Wander Analyst system. It focuses on using a mouse to access the options provided by the pull down menus.

Software Installation

Distribution Diskette Contents

The program distribution diskette contains the following source files:

- SETUP.EXE - Self extracting Install file
- WANDER~1.001, WANDER~2.002 - Compressed program files
- README.1ST - Instructions for extracting and configuring the program.

Installation Procedure

1. Put the Wander Analyst program diskette into the diskette drive.
2. From the Windows Explorer (Win95), Run the file SETUP.EXE. This install program will prompt the user for which subdirectories to place the files. The install program will also create the appropriate Program icons and Program shortcuts.

This install will unpack the following files:

File Name	File Use
wanalyst.exe	Application to run program
wan5.uir	UIR file
uninst.exe	Application to uninstall program
unist.lrm	LRM file
Unist.dll	Application extension
wancfg.ini	Configuration file
wander.dat	Text document
wander.mti	MTIE sample file
wander.tdv	TDEV sample file

Release	Directories	Program Group (name of icon)	Program Item
6.0	Tek-WA6-32	Tektronix	Wander Analyst
5.0	CVIRTE, TD2	Tektronix	Wander Analyst
4.2	WANDER, CVIRTE	Tektronix	Wander Analyst
3.x	TD, CVIRT	TDEV/MTIE for Windows	TDEV/MTIE for Windows

Releases 6.0, 5.0 and 4.x have uninstall capability. To remove an earlier release of software, use File Manager to delete directories and Program Manager to delete Program Item and Program Group.

Program Configuration

Before running Wander Analyst for the first time, it must be configured for your PC. The configuration will be saved and used each time the Wander Analyst program is run. Make choices from the menu bar at the top of the main Wander Analyst screen.

1. Select (screen) monitor choices, output device (printer) and set preferences.
2. Exit the screen after making choices and setting preferences.

Port Configuration

For the Wander Analyst program to upload data the communication ports and program must be properly configured and connected. If the SJ300E indicates setup problems on the front panel, or no readings are displayed, the SJ300E may be unable to send data to the program and could abort the uploading process. Either the RS-232C or GPIB interface can be used as follows:

RS-232C Port Setup

1. Using a straight through cable connect the CTS 850 or SJ300E RS-232C port on the back panel to either COM1, COM2, COM3, or COM4 on the Personal Computer (PC). Wander Analyst may be configured for any listed PC communication port.
2. On the CTS850 or SJ300E and the Personal Computer (PC) configure the RS-232C and COM ports. On the CTS850 or SJ300E, select RS-232C from the appropriate menus and set the following:
 - Data Transfers to: 9600 baud, even parity, 8 bit character size
 - End Of Line (EOL) to: CR-LF
 - XON/XOFF flow control to: OFF

The Wander Analyst program must also be configured for either COM1, COM2, COM3, or COM4 through the Port Setup selection from the Communication pull-down menu, explained in the *Communication, Port Setup* section of this chapter.

GPIB Port Setup

1. Connect a standard IEEE-488 GPIB cable between the CTS850 or SJ300E GPIB port and the GPIB-PCII/IIA connector on the PC.
2. The GPIB setup on the CTS850 or SJ300E should be set to match the Wander Analyst GPIB address. The Terminator should be set to End Or Identify (EOI).

Program Startup

Wander Analyst Program Startup

Version 6.0 of the Wander Analyst software supports both the CTS 850, and the SJ300E. To support both systems, the Wander Analyst software, at the first time communications with a test set is established, will try to determine the type of device it is connected to.

When the program is started, or after the communications settings have changed, beginning a data upload will display a status screen indicating that the Wander Analyst software is auto-detecting the attached device (CTS 850 or SJ300E). Once detection is complete, the program proceeds in a normal fashion.

This auto-detection routine is also run whenever the user performs a communications test. If the attached unit is change from a CTS 850 to a SJ300E, differences in the remote interface will cause an upload failure unless the auto-detection procedure has run.

During startup the Wander Analyst program looks at all available disk drives on the system. If a removable disk drive, such as a CD-ROM drive, has no disk in it, the system will indicate that a problem is present and ask the user to choose between *Abort*, *Retry*, *Fail*. Selecting *Fail* will allow the program to continue.

When the program starts the Wander Analyst screen will be displayed for a few seconds, then the run screen will come up. Next it will plot the default TIE data stored in the file *WANDER.DAT* if it exists, otherwise the graph will be blank.

Program First Start

The first time the program is run the graph may be blank or contain erroneous data, until the full path name of the upload file is set or verified. The *Upload Filename* command under the *Upload* pull-down menu is used to select the drive, directory, and file name as described in the Upload Data Setup section of this chapter.

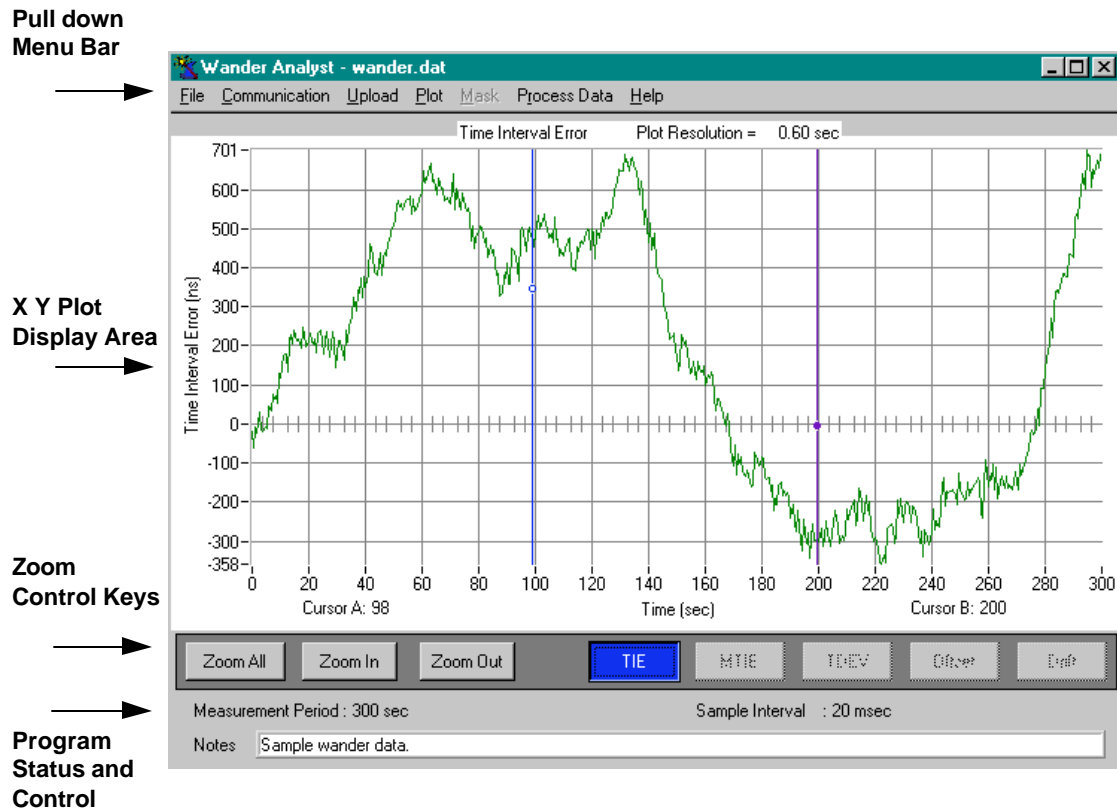
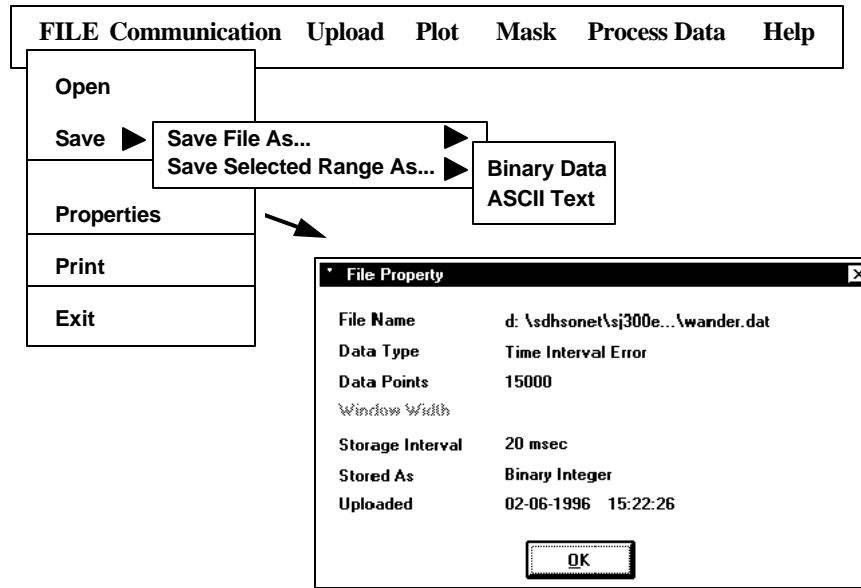

Figure 1-2. Wander Analyst Software Display and User Interface.

File Selection



The following choices are available from the **File** selection in the top menu bar:

Open			Opens a .TIE, .MTIE or .DAT file
Save	Save File As...--> Save Selected Range As...-->	Binary Data ASCII Text	A file can be saved as binary data or ASCII text, or a selected range can be saved as binary data or ASCII text. Saving a selected range involves a Data Start Point and Window Width.
Properties			This choice brings up a menu that shows the properties of the data file currently loaded in the Wander Analyst program. The type of information contained is File Name, Data Type, Data Points, Storage Interval, Stored As, and Uploaded Date. See Screen Capture above.
Print			This choice brings up a menu which permits customization of printing.
Exit			Exits the program.

Communication Selection

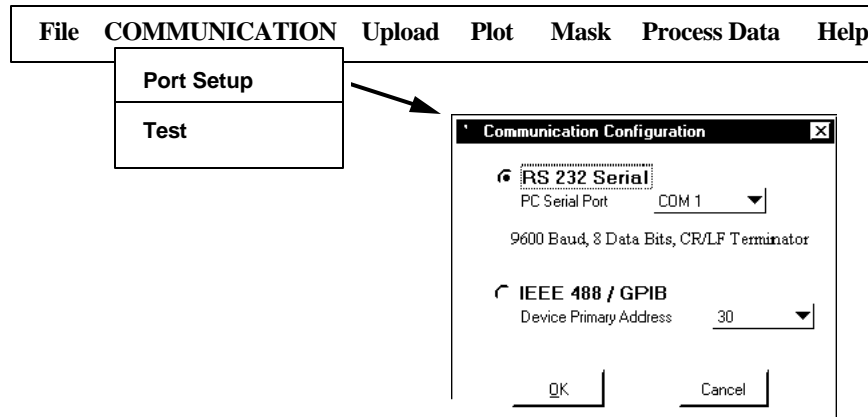

The following choices are available from the **Communication** selection in the top menu bar:

Port Setup	RS 232 Serial IEEE 488/ GPIB	I/O port type and address selection. Permits configuration and selection of RS-232 and GPIB interfaces. The GPIB interface requires that a National Instruments-compatible driver already be loaded.
Test		The Test function tests the communication between the Wander Analyst software and the SDH Analyzer. The Wander Analyst software performs a *idn command asking for the test unit's software version. This information is displayed and the test is successful if communication is properly established.

Port Setup

To select RS-232C or GPIB, click on the respective button, and the current value will be highlighted.

To set the serial port on the PC, select RS-232C, click on the Serial Port selector, and pick COM1, COM2, COM3 or COM4.

To set the GPIB address for the SJ300E or CTS 850, select GPIB, click on the Primary Address Selector, and pick the desired address.

If the I/O type is set to GPIB and the GPIB driver is not loaded, all communications, including RS-232C, may be disabled. If this occurs, exit and restart the Wander Analyst program to initialize the RS-232C communication port. Or load the GPIB driver before running the Wander Analyst program.

Once the Communication configuration is set, you may test it with the Comm Test option from the Communication pull-down menu.

The communications setup is stored on disk when Wander Analyst was configured, and will not have to be re-entered unless the configuration changes or the configuration file **wancfg.ini** is lost.

Uploading Data Setup

Upload Configuration Menu

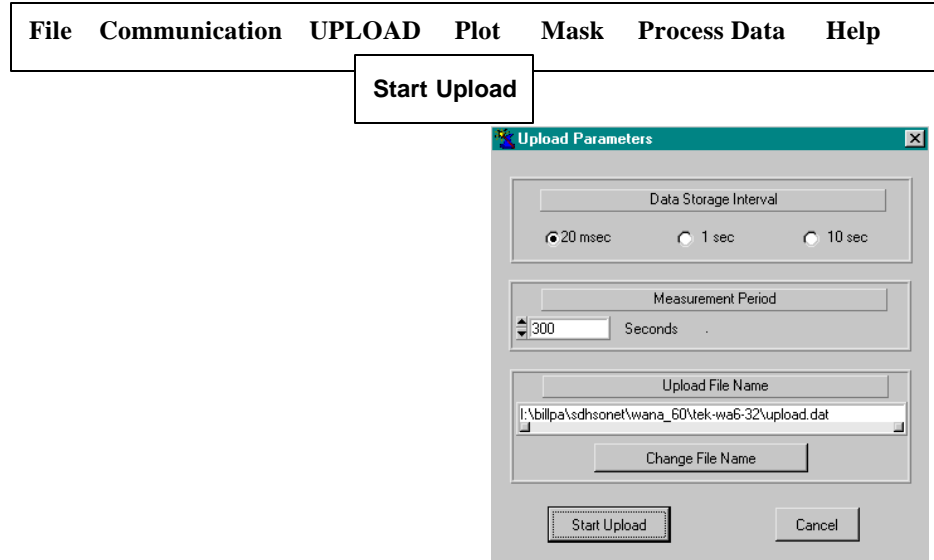

The following choices are available from **Upload** selection in the top menu bar:

Data Storage Interval	20 msec 1 sec 10 sec	<p>The Wander Analyst program normally stores all of the data uploaded from the test unit. Since data is generated in 20-millisecond intervals, this is generate a large data file. As an option, the user can elect to store data at one-second or 10-second intervals. The MTIE and TDEV calculated <i>during</i> the upload will use all of the data, but the TIE data stored to disk will be averaged to create one sample per second.</p> <p>NOTE: Using TIE data stored at one-second intervals will not generate the same TDEV/MTIE results as the 20-millisecond upload. The one-second data will be less accurate than the 20-millisecond data. However, the tradeoff is that the one-second data takes up less disk storage space</p>
Measurement Period	___ seconds	<p>Sets the period for uploading in seconds. The length of the actual upload is determined by the number of samples that would be read in the measurement period (50 samples per second).</p> <p>The measurement period is stored to disk as part of the program configuration, and will maintain the value set when the program is restarted.</p>
Upload File Name		<p>Double-click the file listed in the Upload File Name box to change the name of the file.</p> <p>Select a file for uploading data into. This will change the display to show upload information in the file data area. If the file exists, it may be plotted, but this will not happen by default. The command sub-window accepts a full path name, as follows:</p> <p style="text-align: center;"><i>drive :\directory[subdirectory] filename.ext</i></p> <p>The default is c:\Wander\upload.dat which is sample TIE data file that is provided with the Wander Analyst software</p>

Using the Upload Pull-Down Menu:

- Set the upload filename to a DOS compatible format with the DAT (data) file extension, as shown:

disk:\directory\file_name.DAT

- Select a measurement signal, data storage interval, and a measurement period. Valid ranges are from 10 to 999999 seconds. The end of the upload is determined by the number of samples expected in the selected period. Select the Data Storage Interval of: twenty-millisecond (0.02 sec) for greater resolution; one-second (1.00 sec) or 10 seconds to use less storage space.

NOTE:

MTIE and TDEV files generated while the data is being uploaded at twenty millisecond intervals will reflect that resolution even though the data storage is at a one-second resolution. MTIE and TDEV files calculated from one-second stored data will reflect that resolution.

Uploading Data from the SJ300E or CTS 850

Using the PC left mouse button, click the Start Upload key on the user interface to begin the data upload. The Wander Analyst program will check to ensure it is not overwriting existing data, and display a summary panel of the upload file configuration.

- After starting the data upload, a communication setup error, a SJ300E problem, or a CTS 850 problem can terminate the program. Wander Analyst should report the error or problem that may have occurred.
- The upload may be manually stopped at any time by clicking the Cancel Upload key with the left mouse button. That key is in the same location as the Start Upload key in the program status and control area.

After the first ten seconds of uploading, the TIE, MTIE, and TDEV data is displayed on the screen. That data can be monitored for obvious problems, and testing terminated before hours of collecting data. The real-time TIE, MTIE, TDEV data display will be updated at approximately ten second intervals throughout the upload. The Elapsed Time indicator display is also updated during the upload indicating that the system is running. Completion of the upload is determined by the number of samples loaded.

NOTE:

The start and end times appearing on the real-time display may not always be on even multiples of ten seconds. This occurs because the priority is given to the upload and calculation processes over the display process.

When the data upload is complete a summary will be displayed. It includes the number of data points loaded and time that the upload terminated. Click "OK" to accept the summary. When the summary is accepted, the TIE data for the full upload is displayed, and the TDEV and MTIE plot files are written to the disk.

Graphic Displays

The Wander Analyst software program generates four files, one data and three plot files. The data file contains the raw data that is used to generate all of the plot files. Table 1 describes all four files.

Table 1. Data and Plot files

File Use	Type	Description
Data file	TIE: *.DAT	*.DAT has raw TIE data, but can be plotted itself
Plot files	TDEV: *.TDV MTIE: *.MTI Drift (*.DFT) Offset (*.OFF)	*.TDV is calculated from *.DAT and can be plotted. *.MTI is calculated from *.DAT and can be plotted.

Plot Menu

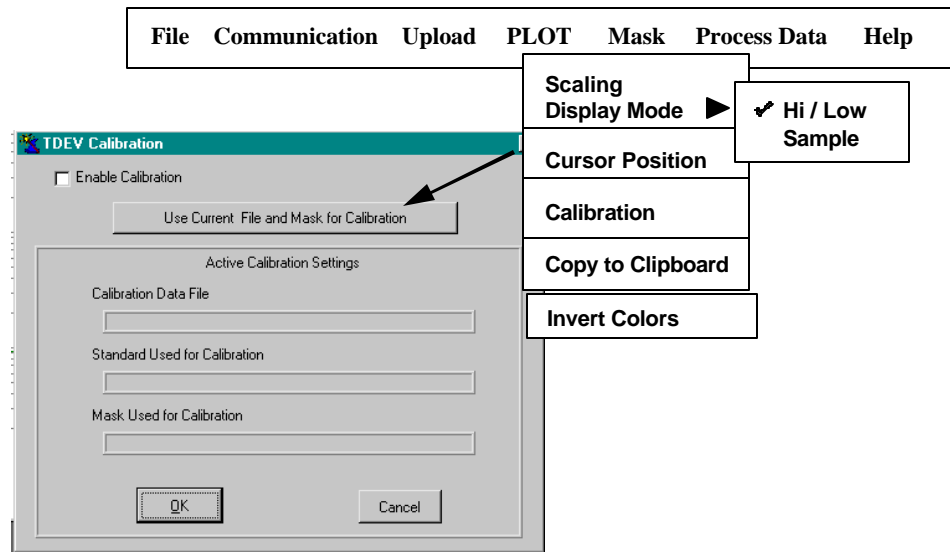

The following choices are available from the **Plot** selection in the top menu bar:

Scaling		<p>Scaling is used for MTIE and TDEV data. If you load a file (instead of uploading directly from the test unit), then you will need to calculate TDEV and MTIE (by selecting Process Data, Calculate TDEV and MTIE).</p> <p>AUTO scaling is the default and informs the software to adjust the graphical display scale to fit all the data.</p> <p>FIXED scaling is based on the scale specified in the standards.</p> <p>USER DEFINED scaling permits the user to select the scale to be used.</p>
Display Mode (TIE) Drift (*.DFT) Offset (*.OFF)	Hi/Low Sample	<p>The SJ300E or CTS850 samples data at 50 samples per second. The Wander Analyst software can store all of those data points (data storage intervals = 20 msec) or it can store one point for every fifty samples by averaging the data points (data storage interval = 1 sec. The high and low values can be displayed graphically by selecting Plot, Display Mode, Hi/Low instead of Sample). The Storage Interval can also be 10 seconds.</p> <p>The data loading process looks at how many samples are in the file, then, if SAMPLE display mode has been chosen, the data loading process reads a sample and skips some, reads another sample, and skips some more. If HI/LOW mode has been chosen, the data loading process reads all the data and plots High and Low points from the interval.</p>
Cursor Position		<p>Change the graph cursor readout from raw seconds to a DD:HH:MM:SS format.</p> <p>Choices: Raw seconds; or HH:MM:SS.</p>

Operating Basics

--	--	--

<p>Calibration (TDEV)</p>		<p>Calibration is used only for TDEV data as it relates to a Wander Transfer measurement. Any transfer measurement has two masks: an input and an output mask. No system can generate a perfect input mask. So the Wander Analyst software permits the test unit to measure its own wander transfer input and calibrate the measured result to the input mask, specified in the standards. Now, when the user performs the actual wander transfer test, the measured wander transfer is adjusted to account for the imperfections of the transfer input signal. The Wander Analyst software will display the actual transfer test results in green and the adjusted transfer test results in magenta.</p>
<p>Copy to Clipboard</p>		<p>The Clipboard is a temporary storage area for text and graphics that you are copying or moving from one location to another.</p>
<p>Invert Colors</p>		<p>This choice permits printing the charts and graphs in black & white. Instead of a black background, the background is white and the grid lines and the plots are in black.</p>

Mask Menu

The Mask menu presents a list of masks that can be displayed for comparison with the current graph.

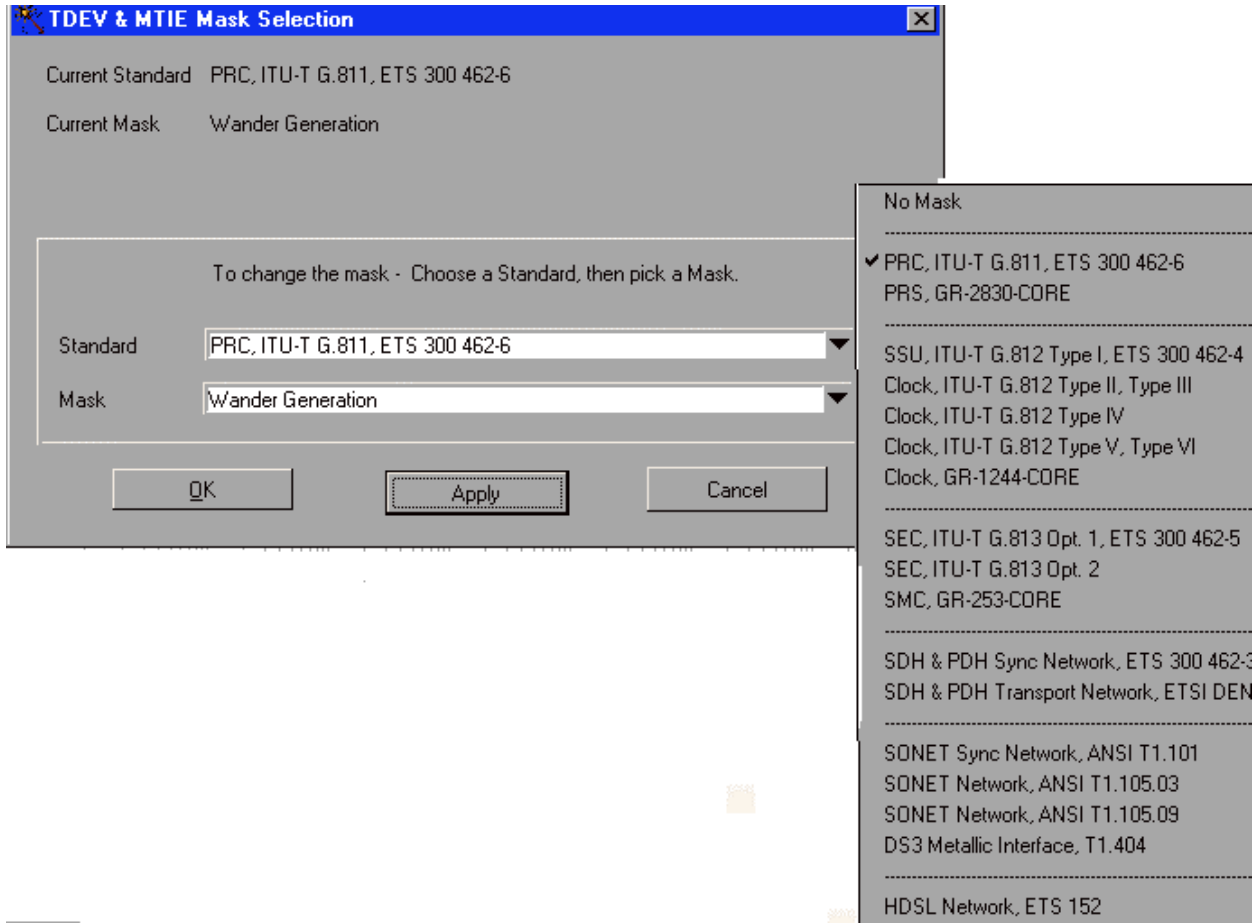

The single selection picks a mask for both TDEV and MTIE. If the mask does not exist for one or the other, that information is displayed on the selection panel. See screen example below.

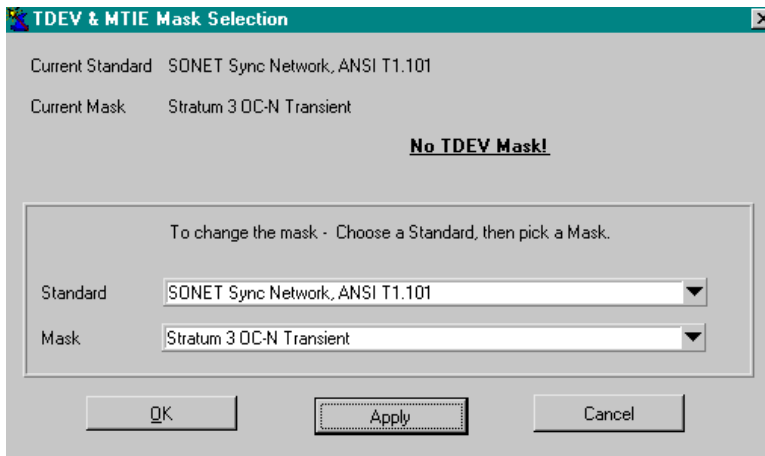

The following choices are available from the **Mask** section in the top menu bar. See the actual masks in the appendix of this user manual.

Standard Selection	Mask Selection
MTIE or TDEV	The single selection picks a mask for both TDEV and MTIE. If the mask does not exist for one or the other, that information is displayed on the selection panel.
No Mask	No Mask
PRC, ITU-T G.811, ETS 300 462-6	Wander Generation
PRS, GR-2830-CORE	Wander Output Phase Transient

SSU, ITU-T G.812 Type 1, ETS 300 462-4	Wander Generation Wander Gen (Var Temp) Wander Tolerance Noise Transfer Transient Response (STM-N)
Clock, ITU-T G.812 Type II, Type III	Wander Generation Wander Tolerance Noise Transfer Transient Response (1.5 Mbit/s) Transient Response (STM-N)
Clock, ITU-T G.812 Type IV	Wander Generation Wander Tolerance Noise Transfer Transient Response (1.5 Mbit/s) Transient Response (STM-N)
Clock, ITU-T G.812 Type V, Type VI	Wander Generation Transient Response
Clock, GR-1244- CORE	Wander Generation Wander Tolerance Wander Transfer (Stratum 2 & 3E) Wander Transfer (Stratum 3) Phase Transient

SEC, ITU-T G.813 Opt. 1, ETS 300 462-5	Wander Generation Wander Gen (Var Temp) Wander Tolerance

	Transient Response
SEC, ITU-T G.813 Opt. 2	Wander Generation Wander Tolerance Noise Transfer Transient Response Holdover Response
SMC, GR-253-CORE	Wander Generation Derived DS1 Output Filtered Sync Interface Wander Transfer Phase Transient Holdover Entry DS1 Mapping DS1 Single VT Pointer DS1 Periodic VT Pointer

SDH & PDH Sync Network, ETS 300 462-3	PRC Output SSU Output SEC Output PDH Output
SDH & PDH Transport Network, ETSI DEN/TM 3067	2 Mbit/s Output Wander (async) 2 Mbit/s Output Wander (sync) 34 Mbit/s Output Wander (async) 34 Mbit/s Output Wander (sync) 140 Mbit/s Output Wander (async) 140 Mbit/s Output Wander (sync)

SONET Sync Network, ANSI T1.101	PRS Output OC-N Interface OC-N Transient DS1 Interface DS1 Transient Stratum 3 DS1 Transient Stratum 3 OC-N Transient Stratum 3 Wander Transfer Stratum 2 & 3E Wander Transfer Stratum 2 Holdover Entry

SONET Sync Network, ANSI T1.105.03	DS1 Mapping DS1 Single VT Pointer DS1 Periodic VT Pointer DS3 Mapping DS3 Single STS Pointer DS3 Burst-of-3 Pointer DS3 Transient Pointer Burst DS Periodic STS Pointer
SONET Sync Network, ANSI T1.105.09	SMC Input & Output SMC Holdover Entry
DS3 Metallic Interface, T1.404	DS3 Interface

HDSL Network, ETS 152	Output Wander

Process Data Menu

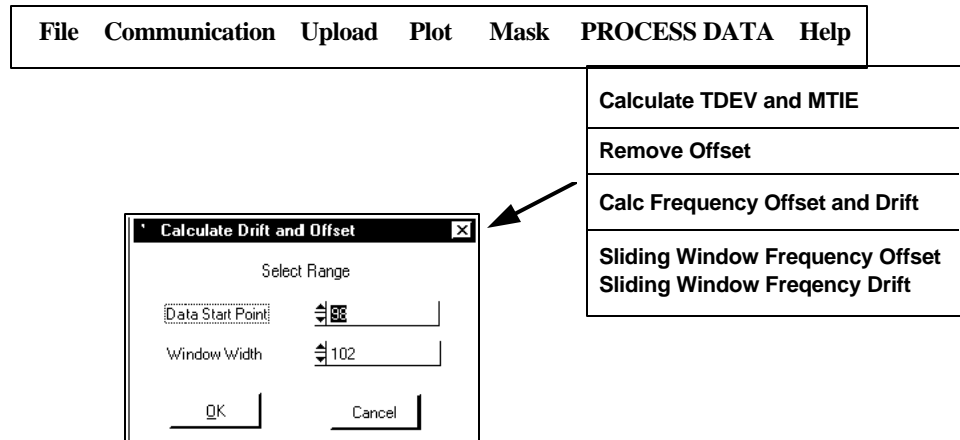

The following choices are available from the **Process Data** selection in the top menu bar:

Calculate TDEV and MTIE		Calculate, and write to disk, TDEV and MTIE data for the currently displayed TIE file.
Remove Offset		Removes average frequency offset from TIE data Wander measurements can be taken with a signal-under-test compared with a reference. That reference must be autonomous (not derived from signal-under-test) and it must be virtually the same frequency (+/- 0.00001 ppm) as the signal-under-test. When the two frequencies are not the same, the result is a phase ramp that invalidates the measurement. The Remove Offset function therefore allows a frequency difference. There are two situations where the user of the Wander Analyst software can encounter this frequency difference: <ol style="list-style-type: none"> 1. The signal-under-test is a PDH signal (for example, DS3) whose frequency is only held to +/- 20 ppm. In general, the frequency is not available at the (remote) measurement site, and the wander reference will have a frequency offset. 2. The signal-under-test is an SDH signal (for example, STM-4) whose frequency is held to +/- 0.00001 ppm. If the test user does not have an expensive Stratum 1 wander reference at the remote measurement site, then a wander reference can be used that is not as accurate in frequency (but is stable) to reduce costs.
Calc Frequency Offset and Drift	Data Start point Window width	The Frequency Offset is the average phase slope over a specified period, defined by the left and right cursor positions. The Frequency Drift Rate is the average second derivative of the phase over the window of time. The left most cursor defines the start time as seconds into the data plot. The right most cursor defines the total frequency offset measurement period in seconds. A submenu allows the numeric cursor position to be entered directly from the keyboard, fine tuning cursor positions. Once calculated, the Offset data can be accepted with an OK button or saved to a file with another button and submenu. The save command allows the

		user to input the full path file name.
Sliding Window Frequency Offset	Select Window width	The frequency offset will be calculated from every window width across the full measurement period and plots the results.
Sliding Window Frequency Drift	Select Range	The frequency drift will be calculated from every window width across the full measurement period and plots the results. Sliding Window Frequency Drift is an equivalent process to MTIE calculation from TIE data. See the graphic representation of this process below.

Sliding Window Frequency Drift

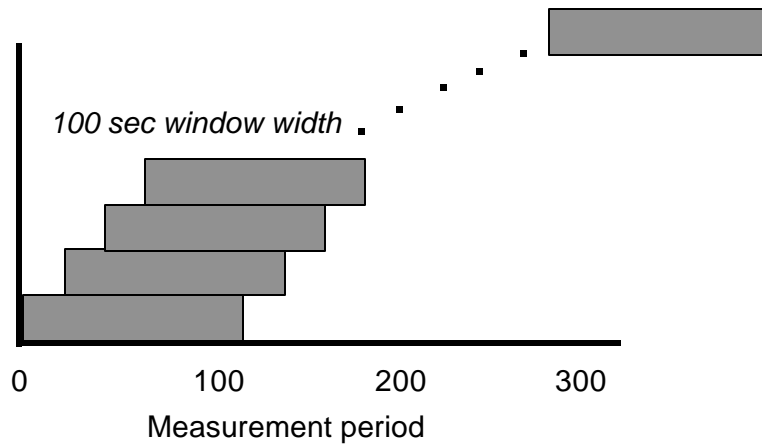

Help Selection

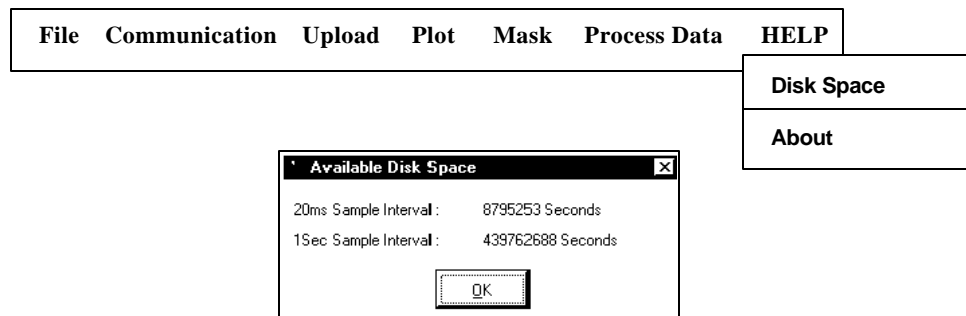

The following choices are available from the **Help** selection in the top menu bar:

Disk Space	Reports the amount of disk space available on the target drive, in seconds of upload time. The target drive was selected by the <i>Set upload file</i> command under the <i>Upload</i> pulldown menu. This feature is not available in the Win 3.1 version. Available disk space (in seconds) = (bytes available - 1024) / 200
About	Displays the Wander Analyst version number

Keyboard Operation without a Mouse

When the Wander Analyst software program is launched it will enter the display control mode. While in that mode the TAB key is used to navigate through the five display controls—Start Upload; three zoom controls; and the cursor controls.

The Page Up and Page Down keys are used to move between the left and right cursors. The four arrows keys move the selected cursor left, right, up, and down. The left cursor can be moved to either side of the right cursor—effectively becoming and functioning as the right cursor. The same is true for both cursors.

Pressing the ALT key and the letter S key simultaneously will access the File pull down menu - entering the menu mode. Then the four arrow keys can be used to navigate through the other menus and their choices. Pressing the ENTER key will activate the highlighted choice.

The ALT I key combination selects Selection menu, ALT U selects the Upload menu, ALT P the PLOT menu, and ALT M the Mask menu. The Process Data menu can be selected by ALT M, then push right arrow key once. The Help menu can be selected by ALT H.

The ESC (escape) key is used to exit the menu mode and return to the display control mode.

Zoom In, Zoom Out, Full

Three buttons on the user interface manipulation the X-axis (Time) displayed on the graph. The cursors define the upper and lower boundaries of the TIE data to be expanded. The Zoom In button changes the graph on screen to view that time interval. Zoom Out backs out the Zoomed-In screen. The Full button returns the screen to the original graph

Reference

This chapter details the theory, functions, and applications of Jitter, Wander, and Phase Transient measurement. It includes the definitions and specifications.

Most of the material in this Reference chapter of the combined Wander Analyst for SJ300E and CTS 850 user manual is specific to the SJ300E. Reference information that applies only to the CTS 850 is still under development. It will be published in the future.

Also included is two technical articles on Jitter and Wander.

The first article, beginning on page 2-16 is "What are the consequences of Jitter & Wander in the Network?" This material comes from the Timing & Synchronization Primer (4/97) prepared by Mark Lum and Dr. Dan Wolaver of Tektronix.

Starting on page 2-32 is a second article, a tutorial on the Principles and Metrics of Jitter & Wander.

Wander Test Functions

The Wander Test functions are:

- Generate Wander and Jitter References
- Measure DS1 Wander Relative to a Reference
- Measure SONET (SDH) Wander Relative to a Reference
- Calculate TDEV
- Calculate MTIE

Generate Wander and Jitter References

When it is equipped with the Wander Test Option, the SJ300E or CTS 850 can emulate the wander and jitter signals that occur in synchronized digital communication networks and network components. Altogether four modulating signals can be generated. Three for wander (below 10 Hz) and one for jitter (above 10 Hz).

Figure 2-1 characterize the wander signal test requirements. These wander masks are selected by setting the wander generation to DS1 for mask 1, DS1 FILT for mask 2, or OCN MASK for mask 3. They are used to see if the measured data conforms to the Bellcore and ANSI standards.

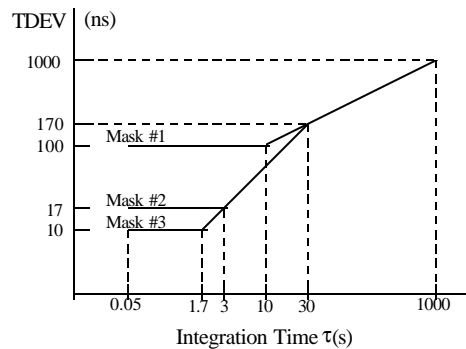

Figure 2-3. TDEV signals and Wander Masks

Pure Clock Signal

The Wander Test Function generates a DS1 (1.544Mbps) 2Mbps, or 2MHz reference with wander or jitter when it is provided with a pure reference signal from a Stratum 1, cesium-based, GPS (Global Position System), or LORAN-based clock (refer to Bellcore GR-1244-CORE).

The pure reference is connected to the EXT REF (external reference) port through a balanced 100 ohm or an unbalanced 75 ohm input. If the pure signal is not applied a NEED EXT REF error message is displayed. The impure DS1 (1.544Mbps) 2Mbps, or 2MHz reference (with wander or jitter) is available at the BITS/SETS OUT rear panel port.

The jitter signal for generating an impure reference is band-limited white noise between 10 and 150 Hz. It generates 1000 ns peak-to-peak jitter with an RMS of

110 ns. The modulation is selected by setting WANDER GENERATION to NOISE JIT, and turned off by setting it to NONE.

Measuring DS1 Wander Relative to a Reference

The Wander Test Option can measure wander on a DS1 (1.544Mbps) 2Mbps, or 2MHz reference when it is provided with a pure reference at the receiver EXT REF port. Connect the signal to be measured to the BITS/SETS IN port on the rear panel, and set the WANDER MEASUREMENT to BITS/SETS. Wander (TIE) data is available for uploading from the GPIB or RS-232C interfaces. Data can be uploaded using the Wander Analyst program or by using the Remote Commands listed in the SJ300E User Manual.

Measuring SONET/SDH Wander Relative to a Reference

The Wander Test Option can measure wander on a SONET or SDH signal when it is provided with a pure reference at the receiver EXT REF port. To do so connect the signal to be measured to the OPTICAL IN, CLOCK IN, or DATA IN port. Set the WANDER MEASUREMENT to OCN. Wander (TIE) data will be available for uploading from the GPIB or RS-232C interfaces. It can be uploaded using the Wander Analyst program or by using the SJ300E Remote Commands.

Reference wander relative to a SONET or SDH line signal can be measured using the same connections. If the line signal connected to the OPTICAL IN, CLOCK IN, or DATA IN port is defined to have no wander, then the Wander TIE data uploaded has the same time interval error (TIE) as the external reference signal.

Calculate TDEV

Time Deviation (TDEV) is a measurement that is used characterize Wander. TDEV is a function of the Integration Time parameter (τ) in seconds. The SJ300E, without the Wander Analyst software, will calculate and display TDEV for one selected Integration Time. The Integration Time may be set to a value between 0.1 and 100 seconds in 0.1 second increments. The Wander Test Option with the Wander Analyst software calculates the TDEV from the uploaded wander data over a range of integration times.

Calculate MTIE

Maximum Time Interval Error (MTIE) is another measurement that is used to characterize Wander. MTIE is a function of a parameter S called Observation Time. The SJ300E, without the Wander Analyst software, will calculate and display the MTIE for one selected Observation Time. The Observation Times may be set to a value between 0.01 and 100 seconds in increments of 0.1 seconds for $S < 1.0$ and 0.2 seconds for $S > 1.0$. The Wander Test Option with the Wander Analyst software calculates the MTIE of uploaded wander data over a range of observation times

Applications

All of the following applications require that the network element under test, an SJ300E or CTS 850, and a PC (Personal Computer) running the Wander Analyst program are already interconnected.

This section provides example applications for:

- Basic Wander Measurement
- Generating Phase Transients
- Phase Transient Conformance Testing
- Wander Transfer Conformance Testing

Basic Wander Measurement

This measurement requires Synchronization Setup, Measurement Selection, and Measurement Execution.

Synchronization Setup

1. Connect a synchronization reference signal to the SJ300E Receiver REF CLOCK input. This should be a pure clock signal—either 1.544Mbps BITS (Building Integrated Timing Supply) 2Mbps SETS (Synchronous Equipment Timing Supply), or 2MHz SETS.
2. Press the EXT key so the indicator light comes on.
3. Press the MENU key twice, moving the cursor to WANDER, and press the ENTER key.
4. Move the cursor to REF SEL and press the ENTER key.
5. Move the cursor to either DS1 (1.544Mbps) 2Mbps (2.048 Mbps), or 2MHz (2.048 MHz), and press ENTER.

Measurement Selection

1. Connect the line signal to the Receiver CLOCK, DATA, or OPTICAL input, and press the SELECT key until the corresponding indicator light comes on.
2. Press the MENU key twice, move the cursor to WANDER, and press ENTER.
3. Move the cursor to WAND MEAS (wander measurement) and press the ENTER key.
4. Move the cursor to OCN or BITS/SETS and press ENTER.

Wander measurements displayed on the SJ300E

1. Press the MENU key twice, move the cursor to WANDER, and press ENTER.
2. Move the cursor to DISPLAY and press ENTER.

Pressing the MENU key will toggle between the Wander Analyst display and the TIE display.



Figure 2-4. SJ300E Display Panel

The front panel will display TDEV for only one value of Tau (τ - Integration Time) and MTIE for only one value of Observation Time.

To select the value of Tau (τ) and Observation Time:

1. Press the F1 key when the cursor is under the TAU value on the screen, and increment or decrement the value (0.1 to 99.9 seconds).
2. Press the F1 key until the cursor is under the OBS value on the screen, and increment or decrement the value (0.1 to 99.0 seconds).

The displayed values of TIE, TDEV or MTIE are history-dependent. Changes in configurations or conditions may give incorrect or erroneous, the RESET key must be pressed to erase past readings.

The full power of the SJ300E Wander features is only accessible when used with the Wander Analyst software program. To upload wander data using Wander Analyst software follow the instructions in *Chapter 2 Uploading Data from the SJ300E*. The figure below illustrates a TDEV plot with its corresponding mask.

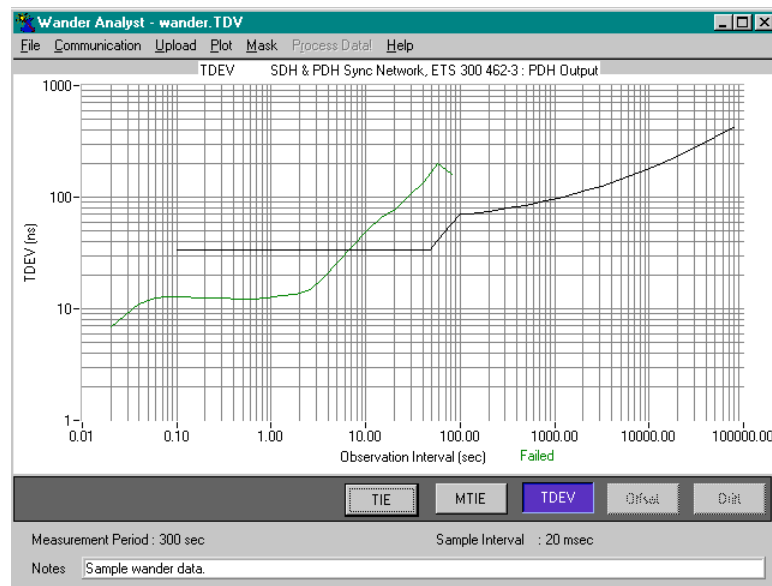

Figure 2-5. TDEV Plot and Mask

Generating Phase Transients

The Phase Transient feature generates a step in phase that is used to validate the transient tolerance and the transient response of the network element under test. This feature requires that the SJ300E Wander Test Option be installed.

The early Model SJ300 Jitter Wander Analyzers with a Wander Test Option installed and firmware versions between 3.9 and 4.9 or 5.5 and above also support the Phase Transient feature. Any other version will require upgrade or replacement.

The phase patterns for Transient generation standards are:

Phase Pattern	Bellcore Standard	ANSI Standard
1000TRAN	GR-253, Sec. 5.4.4.3.2	T1.101-1994, Sec. 7.2.12
1200TRAN	TR-NWT-001244, Sec. 4.4	

The two transients are described by $TIE(t) = 1000 \text{ ns} (1 - e^{-62.8t})$ and $TIE(t) = 1200 \text{ ns} (1 - e^{-62.8t})$, where TIE is time interval error and t is time in seconds. These are plotted below.

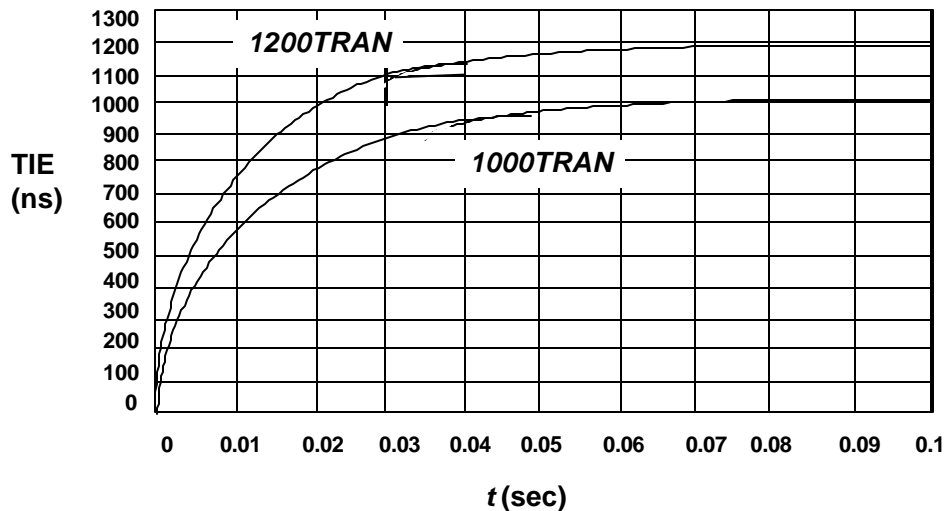

Figure 2-6. Plot of 1000TRAN and 1200TRAN Phase Patterns
Specification for Transient Generation

Note that for 1000TRAN the maximum TIE change in a 1.326-ms interval is 80 ns (compare with 81-ns limit given in T1.101-1994, Sec. 7.2.1.2). The accuracy of these transients is $\pm 2 \text{ ns} \pm 5 \%$.

Phase Transient Generation Procedure

1. Connect a 1.544-Mbps BITS reference to the SJ300E Receiver REF CLOCK, and press the EXT key (light will come on).
2. In the WANDER menu, enter REF SEL, and select (enter) DS1.
3. Enter WAND GEN, select NONE and press the enter key. The BITS OUT signal (rear panel) is now in its quiescent state before the transient.
4. Start the Wander Analyst software program (as detailed in this document) to monitor the trans.
5. Click on the Start button from the Upload menu choice.
6. From the SJ300E WAND GEN menu select either 1000TRAN for specification conformance testing or 1200TRAN to stress for margin. The transients, occur when the ENTER key is pressed. Pressing the Enter Key a second time is not recommended because it will not produce the desired transient. To repeat the transient, steps 3 through 5 must be repeated. The transients are in a direction to shift the phase of the BITS OUT signal earlier by either 1000 or 1200 nanoseconds.

Phase Transient Conformance Testing

Current SONET standards limit the size of phase transients that can be generated by network elements and synchronization clocks during synchronization rearrangement operations. The phase transient limits are specified by the Bellcore and ANSI standards in terms of MTIE (Maximum Time Interval Error).

OC-N Phase Transient Test

Section 5.4.4.3.2 of the Bellcore GR-253-CORE standard sets the phase transient response limits of SONET network elements due to five named rearrangement activities. The standard reads as follows:

"For all SONET network elements except regenerators and loop-timed terminal multiplexes, OC-N/OC-M and STS-N /STS-M electrical outputs shall meet the requirements for phase transients during synchronization rearrangement operations detailed in ANSI T1.101-1994.

Those requirements specify an MTIE of no greater than the requirement in [Bellcore] Figure 5-18. Bellcore GR-253-CORE section 5.4.4.3.2 describes the following five types of network rearrangement activities:

- Manual timing reference switching (the first item in section 5.4.4.3.2)
- Automatic timing reference switching as described in Bellcore Section 5.4.6
- Holdover or free-run entry into self-timing operation for the initial self-timing of 2.33 seconds
- Automatic clock diagnostics
- Phase transients on external or OC-N synchronization input with the rate of change as specified in ANSI T1.101.1994."

ANSI T1.101-1994 section 7.2.1.2 limits the rate of change to 81 ns per 1.326 ms and limits the amplitude to 1000 ns.

Figure 2-5 illustrates the Wander Analyst system configured to test SONET OC-N Phase Transient Specifications conformance. No wander or noise jitter is added to the BITS signal. For information on how to generate no wander, refer to the SJ300E user manual.

While the network element synchronization is being rearranged manually or automatically, the SJ300E receiver measures the OC-N wander. The wander data is uploaded to a PC and used to calculate the MTIE plot.

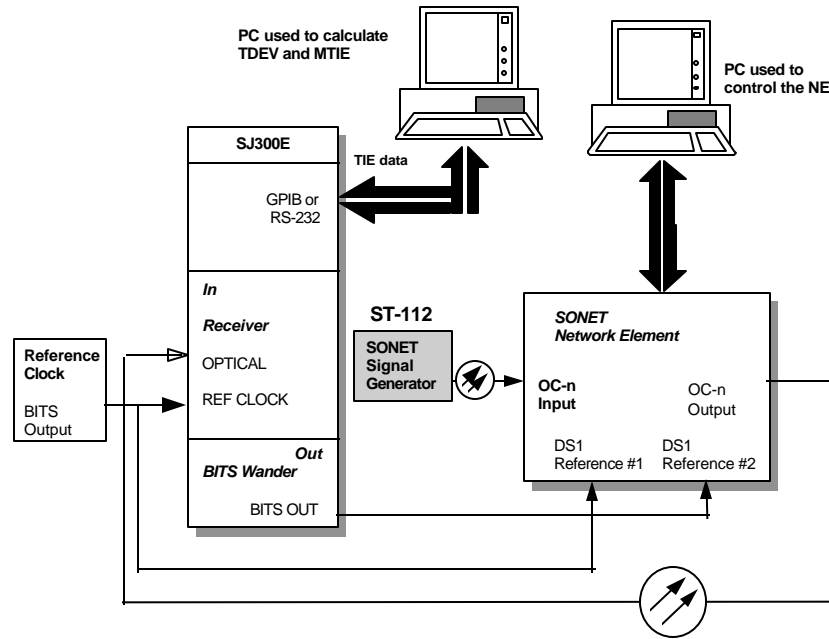

Figure 2-7. SONEC OC-N Phase Transient Specification conformance testing.

To test the five types of rearrangement activities specified under the Bellcore GR-253-CORE Section 5.4.4.3.2 follow the setup instructions for Basic Wander Measurement previously described in this chapter. Figure 2-7. shows the SONEC network element under test with two timing sources. The DS1 Reference 2 passes through the SJ300E (with wander generation set to NONE) to provide a 324 nanosecond phase difference between it and DS1 Reference 1. The SJ300E Receiver monitors wander on the OC-N signal, and the Wander Analyst software calculates MTIE from the uploaded wander data.

To test manual timing rearrangements, provision the SONEC network element to be timed from DS1 Reference 1, allow the system to settle for two minutes and start a 300-second measurement of the OC-N wander. After ten or twenty seconds, reprovision the SONEC network element to be timed from DS1 Reference 2. The measurement is complete when the TIE measurement becomes stable again. Now compare a plot of the MTIE data with the OC-N Transient mask provided by the software. An OC-N or STSX-N signal out of a SONEC network element must meet this mask during synchronization rearrangement operations. (See GR-253 R5-38 and T1.101-1994 7.3.1.2) as follows:

$MTIE = 7.6 + 885 * S$	$0.014 \leq S < 0.5$
$MTIE = 300 + 300 * S$	$0.5 \leq S < 2.33$
$MTIE = 1000$	$2.33 \leq S < 280$
$MTIE = 997 + 0.01 * S$	$280 s < S$

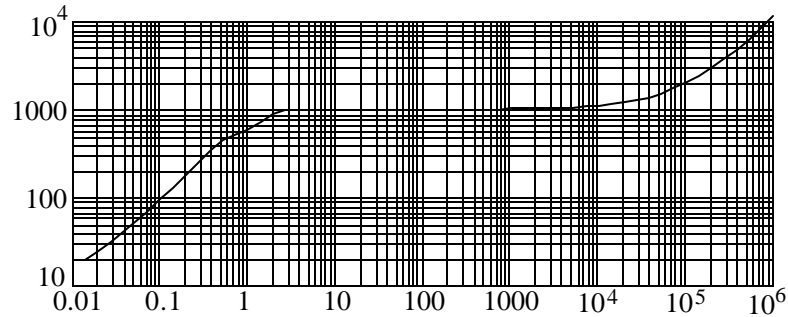

Figure 2-8. OC-N Mask to use with Generating Phase Transient

To be compliant, the MTIE plot must be totally beneath the mask. Repeat this test, changing the provisioning from the DS1 Reference 1 timing to OC-N line timing (OC-n Input).

To test for the last item under GR-253-CORE section 5.4.4.3.2, provision the SONET network element to be timed from the DS1 Reference 1. Set the SJ300E wander generation to NONE, allow the system to settle for two minutes, and start a 300-second measurement of the OC-N wander. After ten or twenty seconds, set the SJ300E wander generation to 1000TRAN, as listed in the procedure in this document. The measurement is complete when the TIE measurement becomes stable again. Compare the plot of the MTIE data with the OC-N Transient mask provided by the software. To be compliant, the MTIE plot must be totally beneath the mask. To test for a 20% margin in being compliant with the specification, repeat the test using the 1200TRAN wander generation setting.

Synchronization Clock Transient Test

There are also phase transient specifications for SONET clocks (BITS clocks, for example), as specified in Bellcore TR-NWT-001244 section 4.4 which reads as follows:

“For all clocks in NEs which support the external timing mode, the clock shall tolerate [i.e., must give no indication of improper operation] phase transients having any MTIE up to 1.20 milliseconds and any TIE discontinuity up to 100 nanoseconds for any measurement period up to 1.326 milliseconds.”

The setup for testing conformance to the clock phase transient criteria is shown in Figure 2-7. Follow the setup instructions earlier in this chapter for basic synchronization reference wander measurement. The steps to perform the phase transient tests also appear earlier in this chapter. The measures of “proper operation” are currently under study by Bellcore. In the interim, the user might use the same transient stress (1000 ns rather than 1200 ns) and the same mask (GR-253, Fig. 5-18) as for the OC-N transient test. This mask is reproduced as Figure 2-6.

Set the SJ300E wander generation to NONE, allow the system to settle for two minutes, and start a 300-second measurement of the DS1 wander. After ten or twenty seconds, set the SJ300E wander generation to 1000TRAN, and press the ENTER key. The measurement is complete when the TIE measurement becomes stable again. Compare a plot of the MTIE data with the OC-N Transient mask. To be compliant, the MTIE plot must be totally beneath the mask. To test for 20% margin in compliance with the Bellcore specification, repeat the test using 1200TRAN wander generation rather than 1000TRAN.

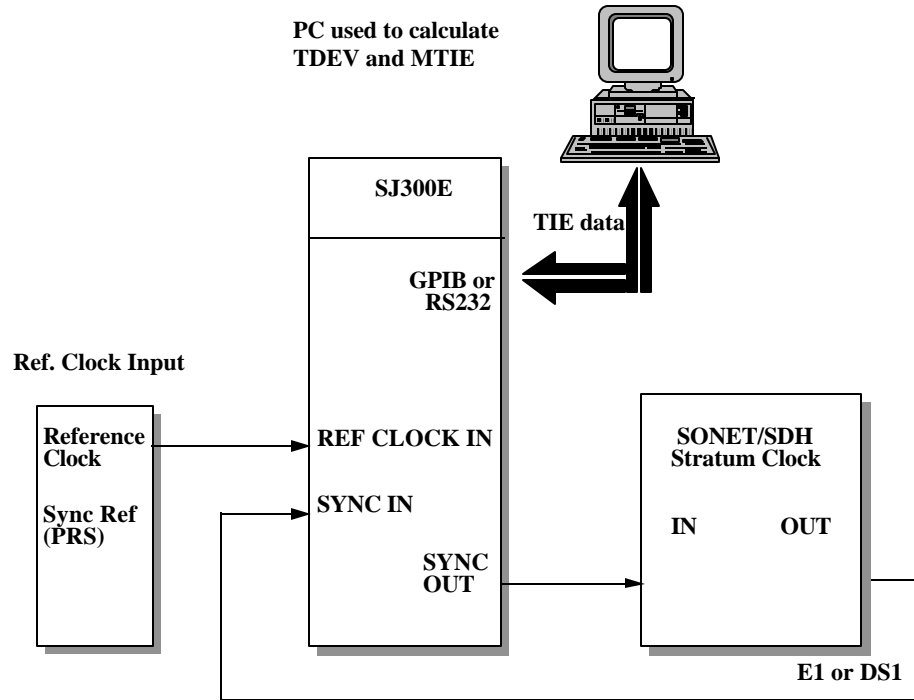

Figure 2-9. Test Setup for Measuring Conformance to Clock Phase Transient

Wander Transfer Conformance Testing

Wander Transfer Specifications

Wander accumulation is aggravated by any amplification of wander by synchronization equipment. Wander transfer specifications require absolutely *no* gain, but in practice, about 2% gain is allowed to account for repeatability problems in measuring wander. Wander is sometimes required to be attenuated for a range of t in order to reduce wander accumulation.

Transfer from DS1 to OC-N

Bellcore GR-253-CORE, section 5.4.4.2.4

R5-125 "OC-N/OC-M and STS-N/STS-M electrical outputs, when referenced to an external DS1 timing signal that meets the wander TDEV mask in Figure 5-15, shall meet the wander TDEV mask given in Figure 5-14."

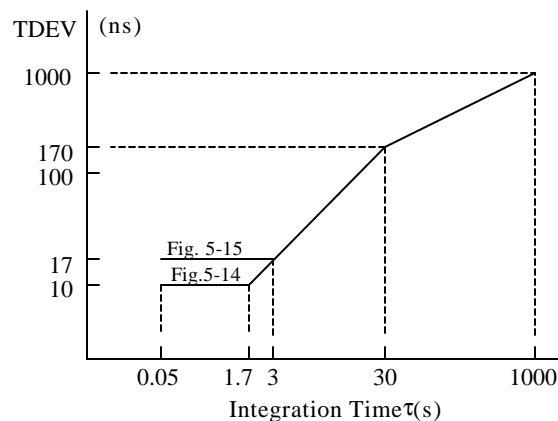

Figure 2-10. OC-N Output Wander Time Deviation (GR-253-CORE Figure 5-14), and Time Deviation of Filtered Network Input to SONET NEs (GR-253-CORE Figure 5-15)

The setup for testing conformance to requirement **R5-125** is shown in Figure 3-8. The SJ300 generates a wandered DS1 reference that just meets the mask of GR-253-CORE, Fig. 5-15. This is used to time the SONET NE under test. The OC-N output from the NE is connected to the SJ300 receiver to measure its wander. The wander data is uploaded to a PC to calculate TDEV.

First reconfigure the setup for calibration by bypassing the SONET NE under test (see dashed line in Figure 2-8). After the SJ300 starts generating the wander pattern, allow the system to settle for two minutes, and then start a 12,000-second calibration measurement of the DS1 signal wander with the TDEV/MTIE software. Calculate correction factors by dividing the calibration TDEV values into the mask TDEV values in GR-253-CORE, Fig. 5-15 (values listed in Appendix B).

Now configure the setup as in Figure 2-8 with the NE under test between the SJ300 transmitter and the SJ300 receiver. Have the SJ300 start the same wander pattern again, allow the system to settle for two minutes, and start a 12,000-second test measurement of the OC-N signal wander. Multiply the test TDEV values by the corresponding correction factors. The results must not exceed the TDEV mask in GR-253-CORE, Fig. 5-14 (values listed in Appendix B) by more than 2%.

Transfer from OC-N to OC-N

Bellcore GR-253-CORE, section 5.4.4.2.4

R5-112 "OC-N/OC-M and STS-N/STS-M electrical outputs, when referenced to a line OC-N timing signal that meets the wander TDEV mask in Figure 5-14, shall meet the wander TDEV mask given in Figure 5-14."

The setup for testing conformance to requirement **R5-126** is shown in Figure 3-9. The SJ300 generates a wandered DS1 reference that just meets the mask of GR-253-CORE, Fig. 5-9. This reference is used to time a SONET signal generator. The resulting wandered OC-N signal is provided to the SONET NE under test, which is provisioned to derive its timing from the incoming OC-N. The OC-N output from the NE is connected to the SJ300 receiver to measure its wander. The wander data is uploaded to a PC to calculate TDEV.

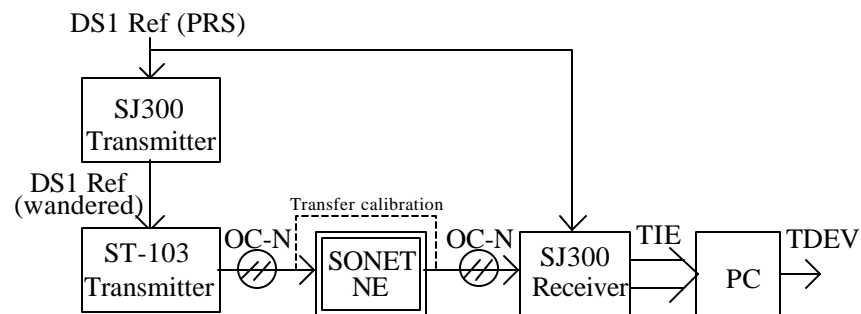

Figure 2-11. Setup for Testing Conformance to Wander Transfer Specification R5-126.

First reconfigure the setup for calibration by bypassing the SONET NE under test (see dashed line in Figure 2-9). After the SJ300 starts generating the wander pattern, allow the system to settle for two minutes, and then start a 12,000-second calibration measurement of the wander. Calculate correction factors by dividing the calibration TDEV values into the mask TDEV values in GR-253-CORE, Fig. 5-14 (values listed in Appendix B).

Now configure the setup as in Figure 2-9 with the SONET NE under test in the OC-N signal path. Have the SJ300 start the same wander pattern again, allow the system to settle for two minutes, and start a 12,000-second test measurement of the wander. Multiply the test TDEV values by the corresponding correction factors. The results must not exceed the TDEV mask in GR-253-CORE, Fig. 5-14 (values listed in Appendix B) by more than 2%.

Wander Tolerance and Transfer for Stratum Clocks

Bellcore GR-1244-CORE section 4.3

“The clock must tolerate (i.e., must give no indication of improper operation, in addition to meeting the limit of Figure 5-3) any arbitrary input signal having wander in conformance with the mask in Figure 4-2.”

Bellcore GR-1244-CORE section 5.4

“When timed by any input signal whose TDEV is less than or equal to the wander tolerance mask in Figure 4-2, the TDEV of the output signal from a clock shall be less than the mask in Figure 5-3.”

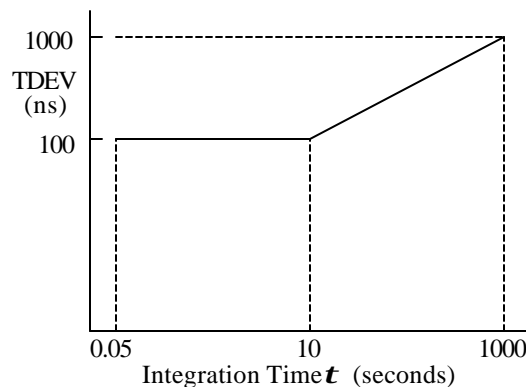

Figure 2-12. Wander Tolerance GR-1244-CORE Fig. 4-2

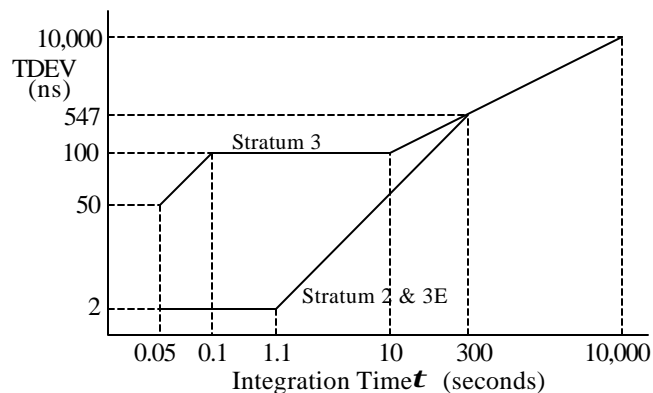

Figure 2-13. Wander Transfer (GR-1244-CORE Fig. 5-3)

The setup for testing conformance to the clock wander tolerance and transfer specifications is shown in Figure 2-11. Provision the Stratum Clock to time from DS1 Reference 1. The SJ300 generates a wandered DS1 reference that just meets the mask of GR-253-CORE, Fig. 4-2. This is used to time the Stratum Clock under test. The DS1 output from the clock is connected to the SJ300 receiver to measure its wander. The wander data is uploaded to a PC to calculate TDEV and see if it falls below the appropriate mask in GR-253-CORE, Fig. 5-3.

First reconfigure the setup for calibration by bypassing the Stratum Clock under test (see dashed line in Figure 2-11). After the SJ300 starts generating the wander pattern, allow the system to settle for two minutes, and start a 12,000-second calibration measurement of the DS1 wander. Calculate correction factors by dividing the calibration TDEV values into the mask TDEV values in Fig. 4-2 (values listed in Appendix B).

Now configure the setup as in Figure 2-11 with the stratum clock under test in the DS1 signal path. Have the SJ300 start the same wander pattern again, allow the system to settle for two minutes, and start a 12,000-second test measurement of the wander. Multiply the test TDEV values by the corresponding correction factors. The results must not exceed the appropriate mask in Fig. 5-3 (values listed in Appendix B) by more than 2%.

What are the consequences of Jitter & Wander in the Network?

By

Dr. Dan H. Wolaver, Tektronix, Chelmsford, MA

and

Mark Lum, Tektronix, European Telecoms Market Development Manager, Marlow, U.K.

As little as one or two years ago, network synchronization was something invisible. It worked and the PDH technology was mature and stable. Now the technology has become unstable and timing/sync has become the first point of contention between inter-connected operators.

Telecommunication networks transport two entities - data and timing - as part of a service. As a result, timing has always been very carefully specified, controlled and distributed within networks, across network interfaces and between customers.

To deliver the timing part of the service, the network must be properly synchronized. Good synchronization is the foundation of Convergence (integrated voice, video and data services). Without management of Timing and Synchronization, Convergence just cannot happen.

The new SDH equipment being installed in public networks around the world represents a quantum leap in performance, management and flexibility for network operators. However, the behavior of a working SDH network is very different from today's existing PDH networks, something that is being more widely recognized as new networks continue their expansion.

The figure on the right illustrates a simple SDH/PDH network model. A PDH circuit is transported over an SDH path, while being multiplexed with other PDH circuits, cross-connected with other SDH payloads and regenerated. The model network is synchronized from a logically separate sync network, although it is likely that sync signals will be physically carried on parts of the SDH network.

In a synchronous network such as the SDH, the timing of a data signal leaving equipment is not necessarily derived from the data entering the equipment.

Referring to this figure, the middle cross-connect (SDH XCONN) takes several AU-4 payloads from its inputs and generates a new aggregate output signal. The timing of its outgoing STM-N signal is determined by a separate synchronization reference signal from the sync network.

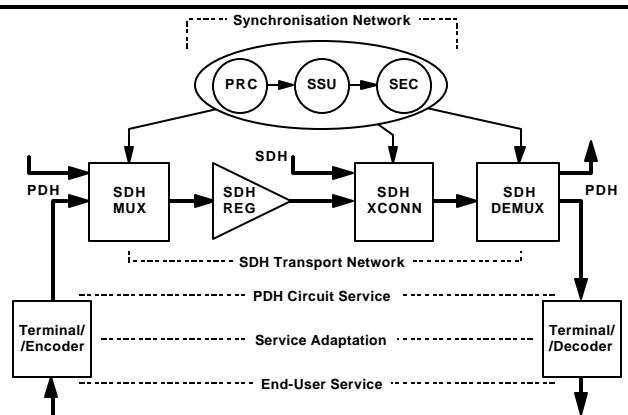

Figure 2-14. Reference broadband network

As little as one or two years ago, network sync was something invisible. It worked and the PDH technology was mature and stable. Now the technology has become unstable and timing/sync has become the first point of contention between inter-connected operators.

As a consequence, Timing and Synchronization are of strategic importance to network operators as they work in the new de-regulated environment of the 1990's.

New Issues in Timing and Synchronization

So this is a time of great change for Timing and Synchronization in the network - over 75% of the relevant technical standards are new or recently-revised. There are many challenges for operators and suppliers - and many new issues to resolve:

- Synchronization networks are changing with the introduction of SDH; the historical PDH-based sync network will be replaced by an SDH-based architecture.
- New equipment and network timing & sync standards have been developed.
- Transport networks are evolving and hybrid SDH/PDH has specific impairments due to the quantisation of network phase variation as pointer justifications.
- New, emerging services like video and ATM depend on excellent network timing & sync to deliver the contractual Quality of Service.
- Jitter/Wander measurement technology is changing from analogue to digital, leading to dramatically new test instrument capabilities.
- New test equipment standards are being developed.

Together with user's data, timing is one entity that is transported end-to-end across the network - no matter what the technology: PDH, SDH, ATM, ADSL, RF - no matter what the service: voice, data, video - and no matter what the application: PBX, GSM, contribution- or distribution-quality video, and so on.

Video Transport in Broadband Networks

New SDH technology offers an ideal mechanism for PTOs, since they can use the same backbone network for all voice, video and data services. Hence video transport services can be provided to customers without the need for dedicated links and organizations.

Irrespective of whether the video is analogue composite or digital component format, using SDH as a transport network technology for video encoded on 140 and 34 Mbit/s data rates may introduce unwanted timing impairments into the service; this is well documented. The impairments can result in distortion and visible picture degradation.

Since video was not considered as a primary service driver when SDH was initially developed, there are important gaps in equipment and interface specifications - some areas of timing performance are undefined and not easily tested. This leads to operational problems that are difficult to identify and resolve, yet have a visible impact on delivered service.

The use of ATM bearers and MPEG-coded video is being evaluated by many operators; initial results are that similar potential timing problems will exist in networks using this technology. It is essential to begin early assessment in practical network configurations, to ensure future success and enable a fast roll-out of services.

Consequences of Jitter and Wander in the Network

PDH Network Systems

In an asynchronous system, timing is derived by phase-locked loops that track the slow phase variations (the wander), so wander is not seen by the system. The jitter component of the phase, which is not tracked, reduces the operating margins of the system. Therefore in an asynchronous system jitter is the main parameter of interest.

SDH Network Systems

In a synchronous system, such as the Synchronous Digital Hierarchy (SDH), both jitter and wander are of interest. There are still phase-locked loops for clock recovery which are sensitive to jitter. But there are also FIFO buffers that are sensitive to wander. These FIFOs operate open loop, depending on inherent synchronization between the write clock and the read clock. Therefore a key parameter of interest is the variation of phase from 10 Hz all the way down to dc, i.e., wander.

Consequences in the Network

There are four major consequences of excessive jitter on a received signal:

- Bit errors can be produced because decision logic circuits do not operate at the optimum time. At high jitter frequencies, the clock recovery circuitry can no longer keep up with the rapid phase changes of the incoming signal. And when the recovered clock gets out of step with the incoming signal by more than 0.5 UI, the signal bit is incorrectly sampled and may cause an error.
- Data can be lost because input buffers can either become empty (too little data being received) or overflow (too much data), causing frame slips, data loss or data repetition - resulting in SES and other defects. Particularly at low jitter frequencies, jitter amplitude can become extremely large (and is theoretically unbounded). The consequences of interconnecting and meshing new synchronous networks together is still largely uncharacterized.
- If the SDH transport is carrying a coded analogue signal, degradation will occur when the analogue signal is reconstructed after it has been demapped from the SDH payload. Jitter on the output digital signal directly causes unwanted phase modulation of the analogue signal. This is not normally a problem with voice and data services, but can be a significant degradation for digitized TV signals which depend on maintaining good low-frequency phase information within tight specifications.
- In new hybrid SDH/PDH networks, a major cause of payload jitter is upstream wander, as the following graphic illustrates:

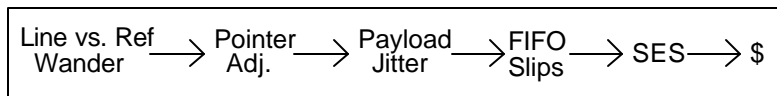

This is a new type of interaction that can be difficult to characterize (since the point in the network where wander is introduced can be quite separate from the point at which its effects are felt).

Testing for Jitter and Wander

This section describes the various measurement techniques and test methodologies used when assessing jitter and wander performance.

Traditional Jitter Tests

Jitter testing has been an established part of the telecoms industry for a long time, and several tests are popular and well-known from their previous use in PDH systems:

- Output Jitter
- Input Jitter Tolerance
- Jitter Transfer Function
- Interface Jitter

New Jitter Tests

Several new jitter tests required for SDH systems are providing new challenges for test equipment. These new sources of jitter are so significant that 50% of the allowed jitter at a demultiplexer PDH output is allocated to them:

- Pointer Jitter
- Mapping Jitter

Pointer jitter is considered to be a more significant source of timing impairment than mapping jitter.

New Wander Tests

New wander tests are rapidly increasing in importance as SDH is more widely deployed:

- Output Wander
- Input Wander Tolerance
- Wander Noise Transfer
- Phase Transient Response
- Holdover Performance

New Service Quality Tests

A new breed of service-oriented measurement is making an appearance. Network specifications are service-independent by definition, but some services require a more stringent timing performance and may be specified using different parameters - one example is digital video, where the user needs to test the Video Timing Quality.

Jitter/Wander Test Equipment Operation

Figure 2-13 shows the simplified principle of operation of a conventional test set; the various blocks are described in the following section on **Jitter Measurement** and also in a later section on **Wander Measurement**.

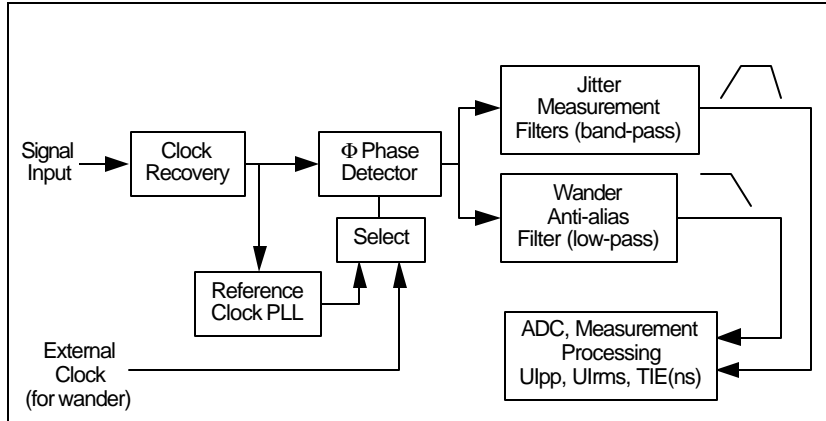

Figure 2-15. Simplified block diagram of jitter/wander test set (measurement functions)

Jitter Measurement and Analysis

Reference Clock

The reference clock is normally taken from the input signal itself, using a PLL timing recovery function. The loop bandwidth must be lower than the lowest jitter frequency to be measured (i.e., the reference clock must not track jitter frequencies to be observed in the test signal).

Conventionally, a 2 to 10 Hz loop bandwidth is used, but new digital technology can easily extend this to 1 or even 0.1 Hz. This allows new measurements of low-frequency phase transients caused by pointer justifications.

The recovered reference clock is used to demodulate any phase variation of the signal under test; this signal is filtered, digitized and made available for further processing.

Measurement Bandwidth

Various measurement bandwidths are used, depending on the bit-rate of the signal, the signal specification and the type of measurement unit. Table 2-1 details the various measurement filters used to construct the jitter measurement bandwidth. The information in the table can be found in ITU-T G.783, Jitter and Wander.

Table 2-1. Jitter measurement filter cut-off frequencies

Data Rate Mbit/s	Peak-to-Peak jitter			RMS jitter	Low-pass filter MHz
	Full-band filter (HP0) Hz *	Wide-band filter (HP1) Hz	High-band filter (HP2) kHz	RMS-band filter kHz	
2	0.1 to 10	20	18	12	0.1
2 (nat'l) **			0.7		
34		100	10		
140		200			
155	0.1 to 10	500	65	12	1.3
622		1000	250		5
2488		5000	1000		20

Notes: * See following sub-section describing full-band measurements
 ** 2 (nat'l) refers to measurements of certain national interfaces

The measurement filters are pictorially shown in Figure 2-14. At Tektronix, we have given names such as “wide-band” and “full-band”, to reduce confusion about these different measurement ranges.

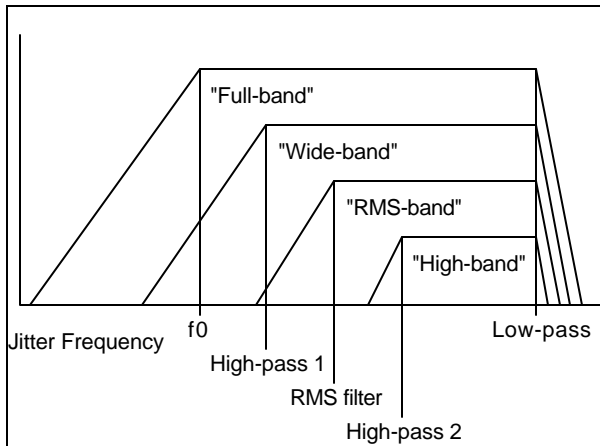

Figure 2-16. Pictorial representation of jitter measurement bandwidths and nomenclature

The low-pass filters are defined as having a 3rd-order 60 dB/decade roll-off characteristic; while the high-pass filters have a 1st-order 20 dB/decade characteristic. The 60 dB/decade low-pass slope is needed to remove the demodulated signal clock component from the measurement.

Full-band Measurements

This measurement bandwidth (selectable high-pass ranging from 0.1 to 10Hz) has been pioneered by Tektronix and is particularly valuable for measuring and diagnosing jitter due to pointer justifications. Significant phase energy is present at low frequencies which can affect service timing or the performance of terminal equipment. The conventional wide-band filters (for example, 100 and 200Hz) do not permit measurement at these frequencies.

Phase Transient Tolerance

Previously an unimportant characteristic of jitter/wander test equipment, this has become very important when measuring hybrid SDH/PDH systems.

Pointer Hits on PDH tributaries can cause older jitter/wander test sets to lose lock, exceed their measurement range and cause unreliable and inaccurate measurements to be made. Even newly-designed test sets may have limitations if this has not been a design criteria.

The answer is to ensure that jitter/wander test equipment is able to tolerate the pointer-induced phase transients that are present on modern PDH services.

Filter Cut-off Frequency Accuracy

The accuracy of the high-pass filter characteristic is a critical feature at low jitter frequencies due to the high amplitude of low-frequency pointer jitter.

Traditional jitter test sets can have non-ideal responses below a jitter/wander frequency of typically 10 to 20Hz, due to the PLL operating characteristics. In historical PDH networks, this is not an issue.

In the new SDH/PDH networks, however, variations in frequency response below the -3 dB point can have a significant impact on measurement results. There is a one-to-one relationship between jitter measurement accuracy and filter cut-off accuracy at 10Hz, for example.

Unless the filter is well-controlled, measurement results of pointer jitter will be poorly controlled, unreliable and inaccurate.

Measurement Units

Unit Intervals are either measured as a Peak-to-Peak measurement (in any of the above bandwidths), or an RMS measurement (in which case the 12kHz bandwidth applies).

In addition, measurements of +Peak and -Peak are useful, particularly when diagnosing pointer jitter problems since this type of jitter is asymmetrical, unlike the higher-frequency jitter components.

Measurement Period

The conventional measurement period is 60 seconds. This provides good repeatability for most jitter measurements, and a Peak-to-Peak measurement will converge quite quickly to the correct reading.

The one exception is when measuring pointer jitter, since the measurement result needed is due to discrete, often infrequently-occurring pointer events. So results can vary widely from the “steady-state” condition where no pointer justifications are occurring, to the condition when pointer justification are present. This must be taken into account when making controlled tests.

Jitter Generation and Modulation

Jitter Modulation - Sine

The standard modulation signal when generating jitter is a sinewave. This is a good, repeatable test signal to use for input jitter tolerance tests and jitter transfer function tests. Note that this test signal is not intended to be representative of the type of jitter to be found in practice in a network.

Digital Test Patterns

Because different digital test patterns have different spectral content, it is necessary to specify what type of pattern is to be used when testing PDH systems. The test patterns themselves are defined in O.151 and are summarized in Table 2.

Table 2-2. Digital test patterns (ref. ITU-T G.823)

Data Rate Mbit/s	Digital Test Pattern
2	$2^{15} - 1$
34	$2^{23} - 1$
140	

Since SDH is scrambled immediately prior to transmission, it is not necessary to define specific test patterns for jitter measurements, although the test signal will almost certainly contain some type of structured test payload.

Frequency Offset

For some tests, it may be desirable to offset the test signal in frequency by the maximum positive and negative offsets allowed, in addition to generating jitter. This could be considered to be a worst-case test. For reference, the relevant offsets from G.703 and G.813 are summarized in Table 3.

Table 2-3. Maximum frequency offset

Data Rate Mbit/s	Frequency Offset \pm PPM
2	50
34	20
140	15
155	4.6
622	
2488	

Wander Measurement and Analysis

Refer to the previous Figure 2-13 for the simplified block diagram of jitter/wander test set measurement functions.

The reference clock is normally taken from a signal external to the test set, since it is not possible, at least in a practical way, to recover a suitable reference clock from the incoming signal within a test set.

This would normally be a portable cesium-based clock or a filtered GPS-derived clock. It is not good practice to use a locally available network clock, since that may be the cause of the very problem you are trying to diagnose or the characteristic you are trying to measure!

Having obtained a reference clock, time-interval measurements are made to determine the phase error of the signal under test. This information is made available for further processing.

Measurement Bandwidth

A 10Hz low-pass filter is specified and required in order to ensure accurate measurements of wander, without adding aliased components from jitter.

We recommend that a filter with $\pm 0.2\text{dB}$ passband ripple and a -3dB cut-off frequency accuracy of $10\text{Hz} \pm 15\%$ be used as a minimum requirement (see Figure 2-15). This will ensure that measurement inaccuracy due to filter variation is no more than $\pm 8\%$ (ref. ETS-300-462-3).

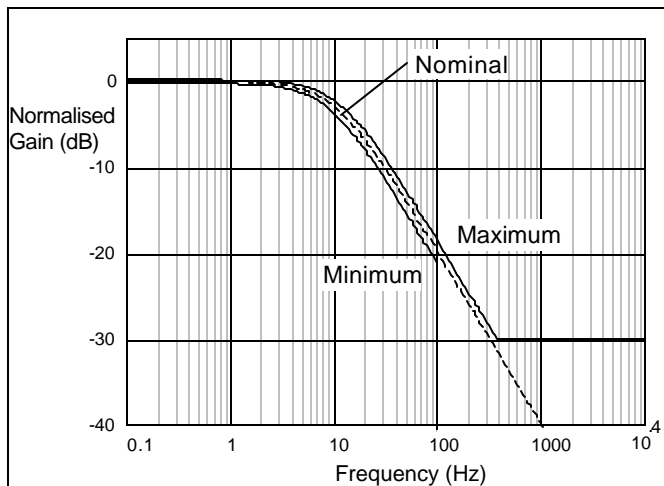

Figure 2-17. Wander measurement filter characteristic (ref. ETS-300-462-3)

Measurement Sample Rate

In addition, the time-interval measurement sample rate has to be high enough to reduce aliasing (in combination with the 10Hz filter) and provide good temporal resolution of phase transients. While the minimum specified by G.813, for example, is 30Hz, we recommend a value of 50Hz which increases the accuracy of measured TDEV for small values of τ .

Measurement Units

Wander is principally measured as TIE (ns). Some specifications still use the equivalent value in Unit Intervals (UI), whilst at very low frequencies, a frequency offset (PPM) reading may be useful. New specifications from ITU-T and ETSI will use the new TIE and MTIE metrics, rather than UI.

The derived metrics of MTIE and TDEV are normally computed externally using PC wander analysis software due to the large volume of measurement data and the processing time required. It is possible to compute MTIE and TDEV during the wander measurement, saving a considerable time of post-acquisition processing.

Measurement Period

To obtain accurate and useful measurements, an extended measurement period may be needed, often over several days or even weeks.

To obtain accurate TDEV results, we recommend that a measurement period T of greater than 12τ be used, where τ is the maximum observation interval needed. As an example from G.813, to measure the value of TDEV for $t=1000\text{sec}$, a measurement period of $T=12,000\text{sec}$ (about 3.3 hours), is recommended.

Wander Generation and Modulation

Wander Modulation - Sine

Sinewave modulation could be considered as a simple extension of the standard jitter test signal, except that it is of a lower frequency - down to 12 μHz or less. However, there are several factors which mean that sinewaves are becoming less useful for testing synchronization performance:

- Due to the low frequencies involved, tests over a range of frequencies can take a considerable time to complete.
- Noise-like signals are useful for testing clock holdover performance and other clock memory-dependent tests.
- New implementations of clocks may not perform correctly when presented with large amplitude sinewave wander modulation.
- Finally, new wander specifications from ITU-T and ETSI are using noise specifications, rather than sinewave.

Let's look at this new "noise" modulation.

Wander Modulation - Noise

The objective is to generate a signal whose phase behavior is such that its MTIE and/or TDEV matches a defined characteristic curve.

The test signal is used for input wander tolerance and wander noise transfer testing; it can be designed to match different TDEV or MTIE characteristic curves. It is also useful for exercising the memory-acquisition of clocks, as a precursor to holdover testing.

Example - Input Wander Tolerance Test

In this example, instead of using a sinewave modulation to test the input tolerance at a specific frequency, we use a special noise-like signal whose TDEV meets the specification requirements. The signal contains all wander frequencies at the correct amplitude, and the test can be completed in a short time.

The figure below shows the TIE or phase characteristic of the special wander noise test signal (obtained by a loop-back test of a wander generator/analyzer).

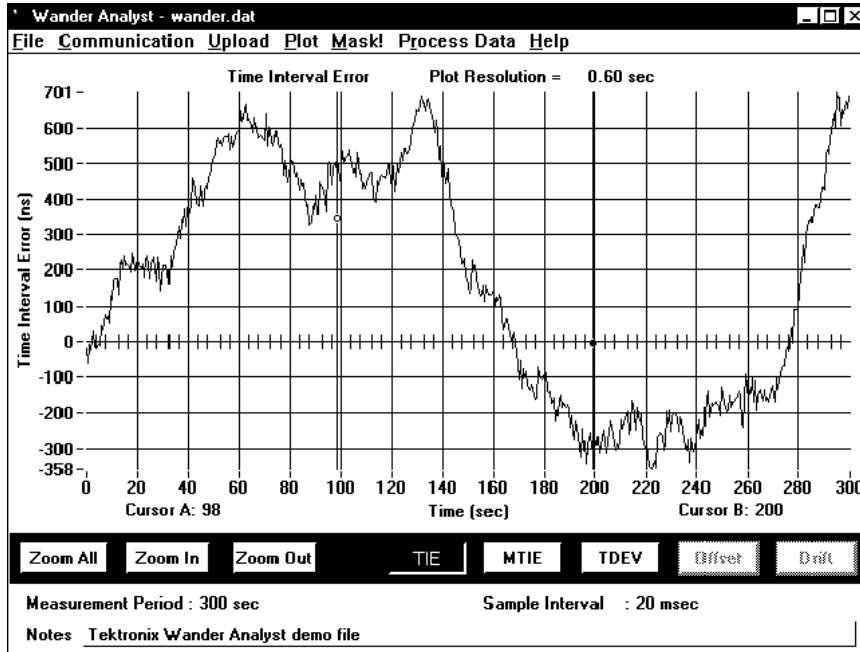

Figure 2-18. TIE phase characteristic of wander noise test signal (G.813 input tolerance test signal)

The TDEV characteristic of this looped-back signal is shown in the next figure. It matches the corresponding input tolerance specification from G.813 within a small error. Note that the statistical deviation at $t > 200$ sec is because the TDEV measurement did *not* exceed the recommended 12τ measurement period.

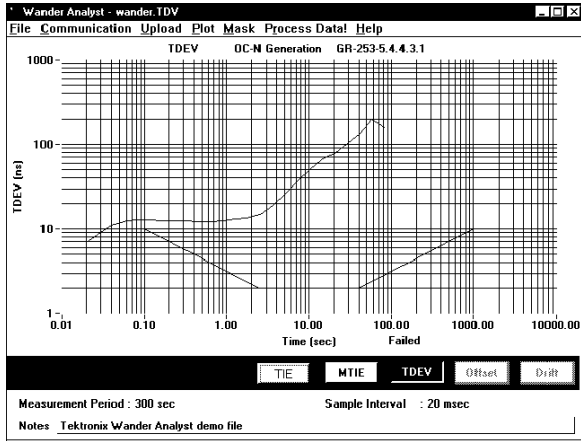

Figure 2-19. TDEV characteristic of wander noise test signal (from G.813 tolerance mask)

Measurement Issues

To ensure sufficiently accurate, robust and consistent measurements using wander noise, the following principles should be applied:

- The test signal should be deterministic, yet sufficiently noise-like over a short observation interval.
- The noise generator should produce a test signal within $\pm 20\%$ of the appropriate input noise tolerance specification.

A suitable noise generator is summarized in Figure 2-18. It uses a PRBS noise generator, which ensures that the same wander is generated for every test, so allowing calibration and normalization routines to be run and ensuring that measurements can be repeated. The noise is filtered and shaped to produce the required TDEV characteristic, and finally applied as clock phase modulation.

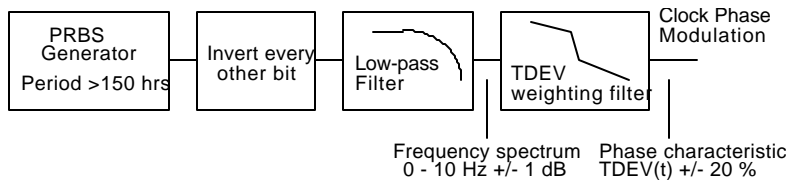

Figure 2-20. Functional model of TDEV noise generator (ref. ETS-300-462-4)

Service Timing Quality Measurement

When a PDH service is transported on SDH, it will suffer timing impairments from pointer adjustments when it is delivered at the far end.

As the hybrid SDH/PDH network becomes more widespread, a single PDH service may cross several “SDH islands”, picking up significant impairment.

Even within single networks, problems have been reported when using terminals such as GSM base stations and PBX equipment - and problems may be anticipated as ATM switches are rolled out. Broadcast video depends on high-quality timing.

Traditional testing has included estimation of bit- and frame-slips due to excessive wander on a 2 Mbit/s service: this is no longer sufficient.

New Measurement Tools

Tektronix is pioneering new measurement methods that can help to establish timing quality parameters on PDH services that have been transported by SDH. The measurements are made on the PDH service and could be correlated with measurements made on the SDH network. Four of these measurements are briefly outlined next.

Pointer Hits

Pointer Hits (phase transients due to pointer justification) can, for the first time, be estimated on the PDH service. As a result, the occurrence of pointer events in the SDH network (which could physically and operationally be some distance away) can be assessed at the service delivery point. This brings very useful benefits to end-users and their service-providers.

Full-band Jitter Measurement

Full-band jitter measurements can be made on the PDH service. As a result, the low-frequency, high-amplitude components of pointer jitter can be measured and evaluated in a way that was not possible previously. The high-pass bandwidth is selectable from 0.1Hz to 10Hz.

Frequency Drift-rate (PPM/sec)

Frequency drift-rate measurements can be made on the PDH service. As a result, the performance of SDH desynchronisers can be evaluated in a new way that was not previously possible.

New types of desynchroniser are becoming available which specifically control this parameter in order to deliver a transient-free PDH service. These will set a new benchmark in timing quality performance.

This measurement may be correlated with payload Video Timing Quality.

Phase Transient Characterization

Using the full-band measurement filters and a traditional analogue demodulated phase output, the phase behavior of PDH services can be evaluated in new ways, particularly useful for system diagnostics.

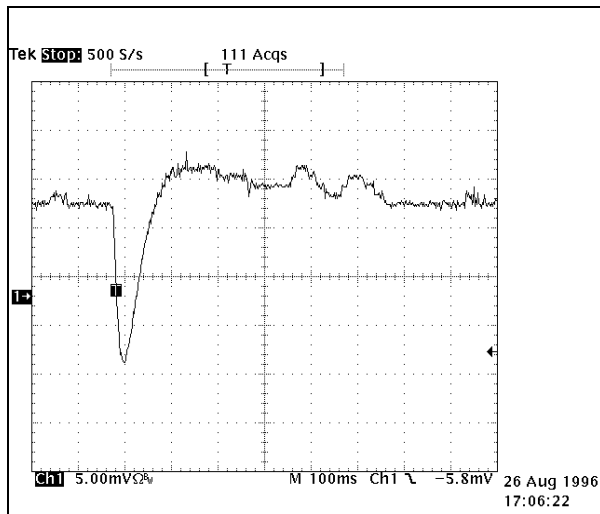

Figure 2-21. Phase transient demodulated from test set

The example output of Figure 2-19 shows a large phase transient due to pointer justification and two smaller transients due to the mapping process. The vertical scaling is 1 UI/div, the horizontal scaling is 100ms/div.

Author Acknowledgments

Dan H. Wolaver PhD

Dan is a Tektronix Fellow working at Tektronix's Broadband Network Test product line in Chelmsford, MA, USA. Author of "*Phase-Locked Loop Circuit Design*" and "*Electrical Engineering for All Engineers*", he is an acknowledged expert in the timing and synchronization field and represents Tektronix on several ANSI and IEEE committees. He has been involved with many aspects of SONET and SDH test and measurement technology.

Mark J. Lum MA MSc

Mark is European Telecoms Market Development Manager, based in Marlow, UK. He manages Tektronix' ITU and ETSI standardization programs and was recently appointed ITU-T Reporter for SDH and PDH jitter/wander test equipment. He is an active contributor on broadband network performance and SDH/ATM test equipment issues.

ITU-T Recommendations

Internet: <http://www.itu.ch>

G.707	Network node interface for the SDH
G.780	Vocabulary of terms for SDH networks and equipment
G.783	Characteristics of SDH equipment functional blocks
G.803	Architecture of transport networks based on the SDH
G.810	Definitions and terminology for synchronisation networks
G.811	Timing characteristics of primary reference clocks
G.812	Timing requirements at the outputs of slave clocks suitable for plesiochronous operation of international digital links
G.813	Timing characteristics of SDH equipment slave clocks (SEC)
G.822	Controlled slip rate objectives on an international digital connection
G.823	The control of jitter and wander within digital networks which are based on the 2048kbit/s hierarchy
G.824	The control of jitter and wander within digital networks which are based on the 1544kbit/s hierarchy
G.825	The control of jitter and wander within digital networks which are based on the SDH
G.958	Digital line systems based on the SDH for use on optical fibre cables
I.432	B-ISDN user-network interface - physical layer specification
O.171	Timing jitter and wander measuring equipment for digital systems which are based on the PDH
O.17s (draft)	Jitter and wander measuring equipment for digital systems which are based on the SDH

ETSI Standards

Internet: <http://www.etsi.fr>

ETS-300-417-n	General functional requirements for SDH transmission equipment
- 1	Generic processes and performance
- 2	Physical section layer functions
- 3	STM-N regenerator & multiplex section layer functions
- 4	SDH path layer functions
- 5	PDH path layer functions
- 6	Synchronisation distribution function
ETS-300-462-n	General requirements for synchronisation networks
- 1	Definitions and terminology for synchronisation networks
- 2	Synchronisation network architecture
- 3	The control of jitter and wander within synchronisation networks
- 4	Timing characteristics of slave clocks suitable for synchronisation supply to SDH and PDH equipment
- 5	Timing characteristics of slave clocks suitable for operation in SDH equipment
- 6	Timing characteristics of primary reference clocks

Glossary & Acronyms

ADM	Add-Drop Multiplexer, ADMUX; common SDH NE
ANSI	American National Standards Institute
ATM	Asynchronous Transfer Mode; cell-based transport and switching
AU-N	Administrative Unit-N; a discrete unit of the SDH payload carrying one or more VC-N
CMI	Coded Mark Inversion; a type of line code used at high bit-rates
DEMUX	Demultiplexer; NE which provides several tributary signals from one aggregate
DSP	Digital Signal Processing
DXC	Digital Cross-connect; common SDH NE that connects payloads between SDH signals
ES	Errored Second; measure of network or equipment performance
ETSI	European Telecommunications Standards Institute
FFT	Fast Fourier Transform; spectral analysis by digital computation
FIFO	First-In First-Out; a type of data buffer
GPS	Global Positioning Satellite; a source of reference timing traceable to UTC
ISI	Inter-Symbol Interference; jitter caused by mis-equalisation
ITU-T	International Telecommunications Union (Telecommunication Sector)
MPEG	Motion Picture Expert's Group; video compression method
MTIE	Maximum Time Interval Error; a measure of wander
MUX	Multiplexer; NE which combines several tributary signals to one aggregate
NE	Network Element; e.g., SDH cross-connect
PCM	Pulse Code Modulation; a method of quantisation for telephony signals
PDH	Plesiochronous Digital Hierarchy; historical transmission system (also a tributary of SDH)
PJE	Pointer Justification Event; or "movement"
PLL	Phase-Locked Loop; method of timing recovery
ppTIE	Peak-to-Peak Time Interval Error , a measure of wander
PRC	Primary Reference Clock; G.811 clock
PTO	Public Telecommunications Operator
REG	Regenerator; NE that amplifies and re-transmits a line signal for long-distance links
rms	Root Mean Square; calculation often applied to power and noise measurements
SDH	Synchronous Digital Hierarchy
SEC	Synchronous Equipment Clock; G.813 slave clock contained within SDH NE
SES	Severely Errored Second; measure of network performance
SONET	Synchronous Optical Network; US implementation of SDH
SSMB	Synchronisation Status Message Byte; part of SDH overhead
SSU	Synchronisation Supply Unit; G.812 slave clock
STM-N	Synchronous Transport Module, level N
TDEV	Time Deviation; a measure of wander
TIE	Time Interval Error; a measure of wander
UI	Unit Interval; a measure of jitter
UIpp	Unit Interval Peak-to-Peak; a common measure of jitter
UIrms	Unit Interval rms; a measure of jitter in line systems
UTC	Universal Co-ordinated Time; internationally-managed reference time
VC-N	Virtual Container-N; a discrete unit of the SDH payload often carrying a PDH tributary
VTQ	Video Timing Quality

Principles & Metrics of Jitter and Wander

Jitter and wander are defined respectively as “the *short-term* and the *long-term* variations of the significant instants of a digital signal from their ideal positions in time”. One way to think of this is a digital signal continually varying its position in time by moving backwards and forwards with respect to an ideal clock source. Most engineers' first introduction to jitter is viewed on an oscilloscope (Figure 3-20). When triggered from a stable reference clock, jittered data is clearly seen to be moving in relation to a reference clock.

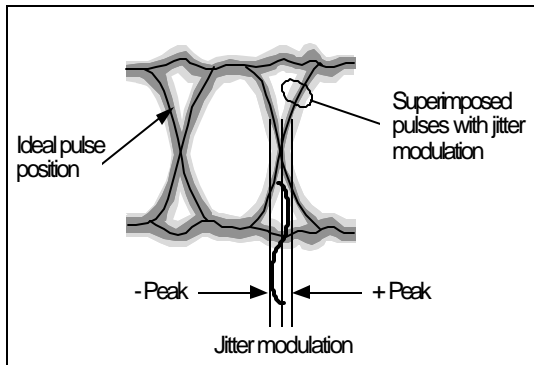

Figure 2-22. Jitter as viewed on an oscilloscope

In fact, jitter and wander on a data signal are equivalent to a phase modulation of the clock signal used to generate the data (Figure 2-21). Naturally, in a practical situation, jitter will be composed of a broad range of frequencies at different amplitudes.

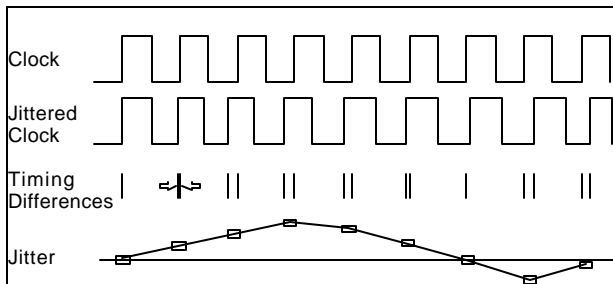

Figure 2-23. Phase variation between two signals

Jitter and wander have both an amplitude: how much the signal is shifting in phase - and a frequency: how quickly the signal is shifting in phase. Jitter is defined in the ITU-T G.810 standard as phase variation with frequency components greater than or equal to 10 Hz whilst wander is defined as phase variations at a rate less than 10 Hz (Figure 2-22).

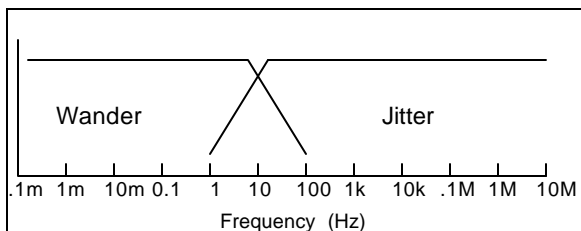

Figure 2-24. Frequency ranges of jitter and wander (ref. G.810)

When measuring jitter or wander, always be sure what the reference clock is. By definition, a signal has no phase variation when referenced to itself - jitter or wander always refers to a difference between one timed signal and another.

Metrics for Jitter

Jitter is normally specified and measured as a maximum phase amplitude within one or more measurement bandwidths. A single interface may be specified using several different bandwidths since the effect of jitter varies depending on its frequency, as well as its amplitude.

UI (Unit Intervals)

Jitter amplitude is specified in Unit Intervals (UI), such that one UI of jitter is equal to one data bit-width, irrespective of the data rate. For example, at a data rate of 2048 kbit/s, one UI is equivalent to 488 ns, whereas at a data rate of 155.52 Mbit/s, one UI is equivalent to 6.4 ns.

Jitter amplitude is normally quantified as a Peak-to-Peak value rather than an RMS value, since it is the peak jitter that would cause a bit error to be made in network equipment.

However, RMS values are useful for characterizing or modeling jitter accumulation in long line systems using SDH regenerators, for example, and the appropriate specifications use this metric instead of Peak-to-Peak.

Metrics for Wander

A wander measurement requires a “wander-free” reference, relative to which the wander of another signal is measured. Any Primary Reference Clock (PRC) can serve as a reference because of its long-term accuracy (10^{-11} or better) and good short-term stability. A PRC is usually realized with a cesium-based clock, although it may also be realized using GPS technology.

Because it involves low frequencies with long periods, wander data can consist of hours of phase information. However, because phase transients are of importance, high temporal resolution is also needed. So to provide a concise measure of synchronization quality, three wander parameters have been defined and are used to specify performance limits:

- **TIE**: Time Interval Error (wander in ns)
- **MTIE**: Maximum Time Interval Error (related to Peak-to-Peak wander)
- **TDEV**: Time Deviation (related to rms wander)

Formal mathematical definitions of these and other parameters can be found in ITU-T G.810 standard.

TIE (Time Interval Error)

TIE is defined as the phase difference between the signal being measured and the reference clock, typically measured in ns. TIE is conventionally set to zero at the start of the total measurement period T . Therefore TIE gives the phase change since the measurement began. An example is given in Figure 2-23. The increasing trend shown is due to a frequency offset of about 1 ns per 10 s, or 10^{-10} in this case.

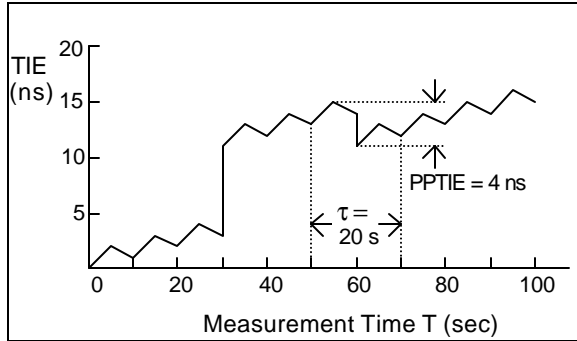

Figure 2-25. Example of TIE wander measurement

MTIE (Maximum Time Interval Error)

MTIE is a measure of wander that characterizes frequency offsets and phase transients. It is a function of a parameter t called the *Observation Interval*. The definition (Figure 2-24) is:

MTIE(t) is the largest Peak-to-Peak TIE (i.e., wander) in any observation interval of length t

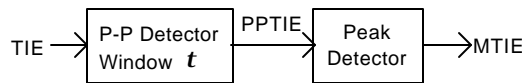

Figure 2-26. Functional definition of MTIE

In order to calculate MTIE at a certain observation interval t from the measurement of TIE, a time window of length t is moved across the entire duration of TIE data, storing the peak value. The peak value is the MTIE(t) at that particular t . This process is repeated for each value of t desired.

For example, Figure 2-23 shows a window of length $t=20$ sec at a particular position. The Peak-to-Peak TIE for that window is 4 ns. However, as the 20 sec window is slid through the entire measurement period, the largest value of ppTIE is actually 11 ns (at about 30 sec into the measurement). Therefore MTIE(20 s) = 11 ns.

Figure 2-25 shows the complete plot of MTIE(t) corresponding to the plot of TIE in Figure 2-23. The rapid 8 ns transient at $t = 30$ s is reflected in the value MTIE(t) = 8 ns for very small t .

It should be noted that the MTIE plot is monotonically increasing with observation interval and that the largest transient masks events of lesser amplitude.

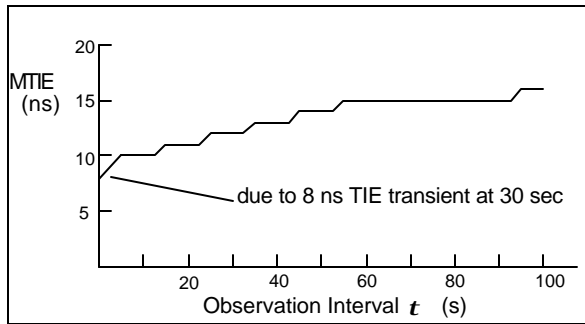

Figure 2-27. Example of MTIE wander measurement (corresponding to Figure 2-23)

TDEV (Time Deviation)

TDEV is a measure of wander that characterizes its spectral content. It is also a function of the parameter t called *Observation Interval*. The definition (Figure 2-26) is:

TDEV(t) is the rms of filtered TIE, where the bandpass filter (BPF) is centered on a frequency of $0.42/t$

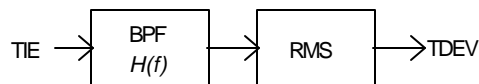

Figure 2-28. Functional definition of TDEV

Figure 2-27 shows two plots of TDEV(t). The first plot (for $T=100s$), corresponding to the TIE data of Figure 2-23 shows TDEV rising with t . This is because, for the short measurement period $T=100s$, the two transients in Figure 2-23 dominate.

If we were to make a longer TIE measurement out to $T = 250s$, the effect of the two transients on TDEV would become less, assuming there are no more transients. The TDEV characteristic labeled $T=250 s$ would be the result.

It should also be noted that TDEV is insensitive to constant phase slope (frequency offset).

To calculate TDEV for a particular t , the overall measurement period T must be at least $3t$. For an *accurate* measure of TDEV, a measurement period of at least $12t$ is required. This is because the rms part of the TDEV calculation requires sufficient time to get a good statistical average.

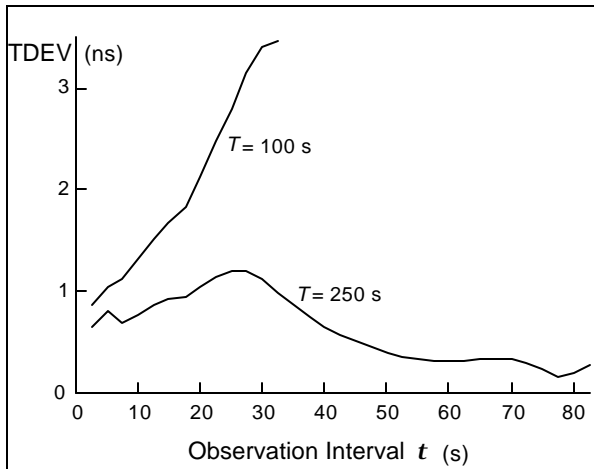

Figure 2-29. Example of TDEV wander measurement (corresponding to Figure 2-23)

Wander Masks

The masks listed in the section are used in Version 6.0 of the Wander Analyst software.

MTIE Masks (SONET)

<p>OC-N Transient (GR-253-CORE, Fig. 5-18) (T1.101-1994, Fig. 8)</p> <p> $MTIE = 7.6 + 885 * S \quad 0.014 \leq S < 0.5$ $MTIE = 300 + 300 * S \quad 0.5 \leq S < 2.33$ $MTIE = 1000 \quad 2.33 \leq S < 280$ $MTIE = 997 + 0.01 * S \quad 280 \leq S \leq 10^6$ </p>	
<p>OC-N Generation (GR-253-CORE, Fig. 5-16)</p> <p> $MTIE = 20 \quad 0.1 \leq S < 1$ $MTIE = 20 * S^{0.48} \quad 1 \leq S < 10$ $MTIE = 60 \quad 10 \leq S \leq 1000$ </p>	
<p>DS1 Generation (GR-1244-CORE, Fig. 5-2)</p> <p> $MTIE = 40 \quad 0.1 \leq S < 1$ $MTIE = 40 * S^{0.4} \quad 1 \leq S < 10$ $MTIE = 100 \quad 10 \leq S \leq 1000$ </p>	
<p>OC-N Interface (T1.101-1994, Fig. 7)</p> <p> $MTIE = 70 + 3.32 * S \quad 0.05 \leq S < 280$ $MTIE = 997 + 0.01 * S \quad 280 \leq S \leq 10^6$ </p>	
<p>DS1 Interface (T1.101-1994, Fig. 5)</p> <p> $MTIE = 300 + 2.5 * S \quad 0.05 \leq S < 280$ $MTIE = 997 + 0.01 * S \quad 280 \leq S \leq 10^6$ </p>	

<p>Derived DS1 (GR-253-CORE, R5-151) MTIE = 50 $0.1 \leq S \leq 1000$</p>	
<p>PRS Output (T1.101-1994, Fig. 4) (GR-2830-CORE) MTIE = $10 + 0.29 * S$ $0.05 \leq S < 1000$ MTIE = $290 + 0.01 * S$ $1000 \leq S$</p>	
<p>SMC Holdover (T1.105.09, Table 2) MTIE = $7.6 + 885S$ $0.014 < S < 0.5$ MTIE = $300 + 300S$ $0.5 < S < 2.33$ MTIE = $884 + 50S$ $2.33 < S < 64$</p>	
<p>SMC Transient (GR-253-CORE, Fig. 5-19) MTIE = $7.6 + 885S$ $0.014 < S < 0.5$ MTIE = $300 + 300S$ $0.5 < S < 2.33$ MTIE = 1000 $2.33 < S < 280$</p>	

TDEV Masks (SONET)

<p>OC-N Generation (GR-253-CORE, Fig. 5-17) (GR-1244-CORE, Fig. 5-1)</p> <p>TDEV = $3.2 * t^{-0.5}$ $0.1 \leq t < 2.5$ TDEV = 2 $2.5 \leq t < 40$ TDEV = $0.32 * t^{0.5}$ $40 \leq t < 1000$ TDEV = 10 $1000 \leq t \leq 10^4$</p>	
<p>OC-N Interface (T1.101-1994, Fig. 9) (GR-253, Fig. 5-14)</p> <p>TDEV = 10 $0.05 \leq t < 1.73$ TDEV = $5.77 * t$ $1.73 \leq t < 30$ TDEV = $31.6 * t^{0.5}$ $30 \leq t \leq 1000$</p>	
<p>DS1 Interface (T1.101-1994, Fig. 6)</p> <p>TDEV = 100 $0.05 \leq t < 10$ TDEV = $31.6 * t^{0.5}$ $10 \leq t \leq 1000$</p>	
<p>DS1 Filtered (GR-253-CORE, Fig. 5-15)</p> <p>TDEV = 17 $0.1 \leq t < 3$ TDEV = $5.67 * t$ $3 \leq t < 30$ TDEV = $31.62 * t^{0.5}$ $30 \leq t \leq 1000$</p>	
<p>Derived DS1 (GR-253-CORE, Fig. 5-21)</p> <p>TDEV = $3.2 * t^{-0.5}$ $0.1 \leq t < 2.5$ TDEV = 2 $2.5 \leq t \leq 1000$</p>	

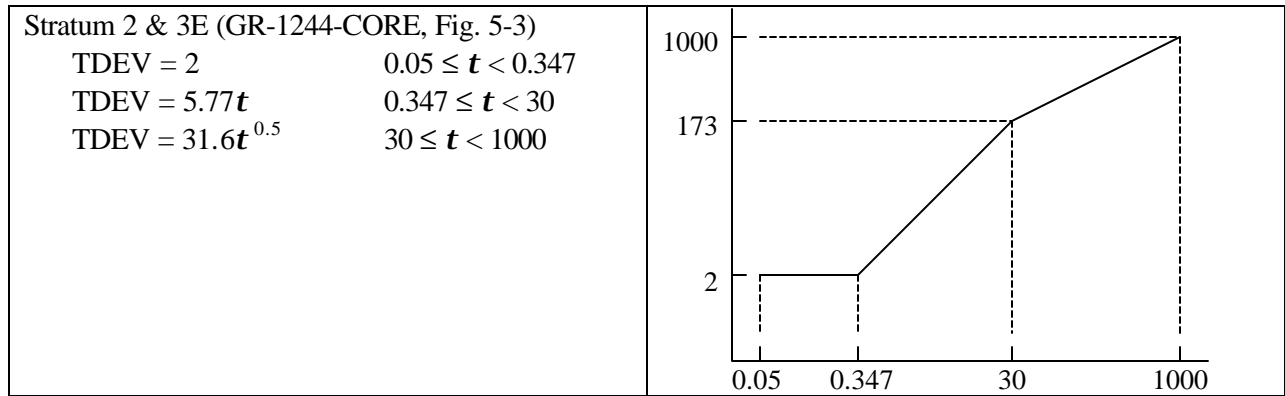

MTIE Masks (SDH)

<p>SEC Generation (ITU-T, Fig. 1/G.813)</p> <p> $MTIE = 40 + 0.5\tau$ $0.1 < \tau \leq 1$ $MTIE = 40\tau^{0.1} + 0.5\tau$ $1 < \tau \leq 100$ $MTIE = 25.25\tau^{0.2} + 50$ $100 < \tau \leq 1000$ </p>	
<p>SEC Gen Const Temp (ITU-T, Fig.1/G.813)</p> <p> $MTIE = 40$ $0.1 < \tau \leq 1$ $MTIE = 40\tau^{0.1}$ $1 < \tau \leq 100$ $MTIE = 25.25\tau^{0.2}$ $100 < \tau \leq 1000$ </p>	
<p>SEC Tolerance (ITU-T, Fig. 5/G.813)</p> <p> $MTIE = 250$ $0.1 < \tau \leq 2.5$ $MTIE = 100\tau$ $2.5 < \tau \leq 20$ $MTIE = 2000$ $20 < \tau \leq 400$ $MTIE = 5\tau$ $400 < \tau \leq 1000$ </p>	
<p>SSU Tolerance (ETS DE/TM-3017-4, Fig. 5)</p> <p> $MTIE = 750$ $0.1 < S \leq 7.5$ $MTIE = 100S$ $7.5 < S \leq 20$ $MTIE = 2000$ $20 < S \leq 400$ $MTIE = 5S$ $400 < S < 1000$ $MTIE = 5000$ $1000 < S < 10^4$ </p>	

<p>PRC Output (ETS DE/TM-3017-3, Fig. 3)</p> <p>MTIE = 25 $0.1 < S \leq 83$ MTIE = $0.3S$ $83 < S \leq 1000$ MTIE = 300 $1000 < S \leq 30000$ MTIE = $0.01S$ $30000 < S$</p>	
<p>SSU Output (ETS DE/TM-3017-3, Fig. 5)</p> <p>MTIE = 25 $0.1 < S \leq 2.5$ MTIE = $10S$ $2.5 < S \leq 200$ MTIE = 2000 $200 < S \leq 2000$ MTIE = $433S^{0.2} + 0.01S$ $2000 < S$</p>	
<p>SEC Output (ETS DE/TM-3017-3, Fig. 7)</p> <p>MTIE = 250 $0.1 < S \leq 2.5$ MTIE = $100S$ $2.5 < S \leq 20$ MTIE = 2000 $20 < S \leq 2000$ MTIE = $433S^{0.2} + 0.01S$ $2000 < S$</p>	
<p>PDH Output (ETS DE/TM-3017-3, Fig. 9)</p> <p>MTIE = 732 $0.1 < S \leq 7.3$ MTIE = $100S$ $7.3 < S \leq 20$ MTIE = 2000 $20 < S \leq 2000$ MTIE = $433S^{0.2} + 0.01S$ $2000 < S$</p>	
<p>PRC Generation (ETS DE/TM-3017-6, Fig. 1)</p> <p>MTIE = $25 + 0.275S$ $0.1 < S < 1000$ MTIE = $290 + 0.01S$ $1000 < S$</p>	

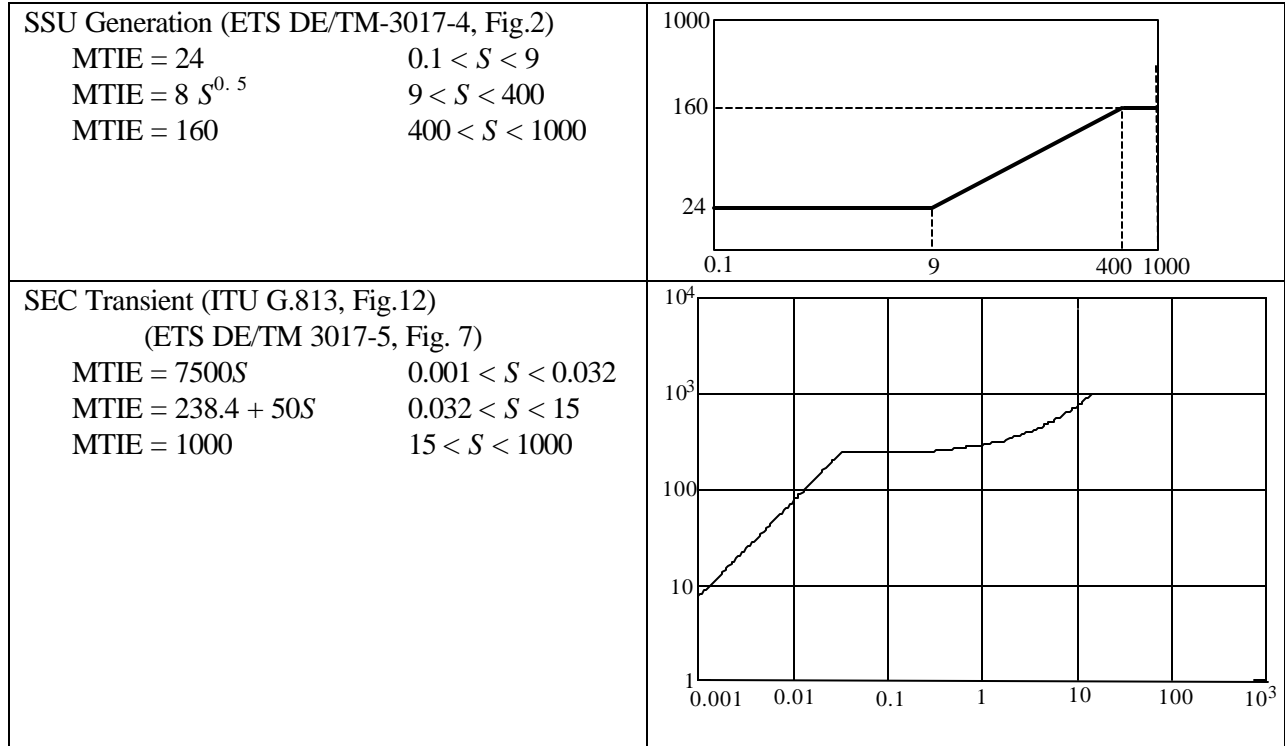

MTIE SEC Transient

The transient out of an SEC due to an up-stream switch is restricted. The specification is given in words rather than by an MTIE mask (see ETS DE/TM 3017-5, section 9.1 and ITU-T Recommendation G.813, section 10.1.) Note that TIE plot referred to in the specification is not an MTIE mask; it is only a summary of the transient specification. Meeting the MTIE mask provided here is a necessary but not sufficient condition for meeting the transient specification.

TDEV Masks (SDH)

<p>SEC Gen Const Temp (ITU-T, Fig.2/G.813)</p> <p>TDEV = 3.2 $0.1 < \tau \leq 25$ TDEV = $0.64\tau^{0.5}$ $25 < \tau \leq 100$ TDEV = 6.4 $100 < \tau \leq 1000$</p>	
<p>SEC Tolerance (ITU-T, Fig. 6/G.813)</p> <p>TDEV = 12 $0.1 < \tau \leq 7$ TDEV = 1.7τ $7 < \tau \leq 100$ TDEV = 170 $100 < \tau \leq 400$</p>	
<p>SSU Tolerance (ETS DE/TM-3017-4, Fig. 4)</p> <p>TDEV = 34 $0.1 < \tau \leq 20$ TDEV = 1.7τ $20 < \tau \leq 100$ TDEV = 170 $100 < \tau \leq 1000$ TDEV = $5.4\tau^{0.5}$ $1000 < \tau \leq 10^4$</p>	
<p>SSU Transfer (ETS DE/TM-3017-4, Fig. 7)</p> <p>TDEV = 3 $0.1 < \tau \leq 13.3$ TDEV = $0.017\tau^2$ $13.3 < \tau \leq 100$ TDEV = 170 $100 < \tau \leq 1000$ TDEV = $5.4\tau^{0.5}$ $1000 < \tau \leq 10^4$</p>	
<p>PRC Output (ETS DE/TM-3017-3, Fig. 4)</p> <p>TDEV = 3 $0.1 < S \leq 100$ TDEV = $0.03S$ $100 < S \leq 1000$ TDEV = $29.7 + 0.0003S$ $1000 < S < 10^6$</p>	

<p>SSU Output (ETS DE/TM-3017-3, Fig. 6)</p> <p>TDEV = 3 $0.1 < S \leq 4.3$ TDEV = $0.7S$ $4.3 < S \leq 100$ TDEV = $58 + 1.2S^{0.5} + 0.0003S$</p> <p style="text-align: right;">$100 < S < 10^6$</p>	
<p>SEC Output (ETS DE/TM-3017-3, Fig. 8)</p> <p>TDEV = 12 $0.1 < S \leq 17.14$ TDEV = $0.7S$ $17.14 < S \leq 100$ TDEV = $58 + 1.2S^{0.5} + 0.0003S$</p> <p style="text-align: right;">$100 < S < 10^6$</p>	
<p>PDH Output (ETS DE/TM-3017-3, Fig. 10)</p> <p>TDEV = 34 $0.1 < S \leq 48$ TDEV = $0.7S$ $48 < S \leq 100$ TDEV = $58 + 1.2S^{0.5} + 0.0003S$</p> <p style="text-align: right;">$100 < S < 10^6$</p>	
<p>PRC Generation (ETS DE/TM-3017-6, Fig.2)</p> <p>TDEV = 3 $0.1 < S < 100$ TDEV = $0.03S$ $100 < S < 1000$ TDEV = 30 $1000 < S < 10^4$</p>	
<p>SSU Generation (ETS DE/TM-3017-4, Fig.1)</p> <p>TDEV = 3 $0.1 < \tau < 25$ TDEV = 0.12τ $25 < \tau < 100$ TDEV = 12 $100 < \tau < 1000$</p>	

Where the Masks Apply (SONET)

MTIE OC-N Transient

An OC-N or STSX-N signal out of a SONET network element must meet this mask during synchronization rearrangement operations. (See GR-253-CORE, 5.4.4.3.2 and T1.101-1994, 7.3.1.2)

MTIE OC-N Generation

An OC-N or STSX-N signal out of a SONET network element must meet this mask when timed with a wander-free reference. The reference shall, however, have white jitter of 1 μ s p-p bandlimited from 10 Hz to 150 Hz. (see GR-253-CORE, 5.4.4.3.1.)

MTIE DS1 Generation

The output of a stratum 2,3, or 3E clock must meet this mask when timed with a wander-free reference. The reference shall, however, have white jitter of 1 μ s p-p bandlimited from 10 Hz to 150 Hz. (see GR-1244-CORE, R5-5.)

MTIE OC-N Interface

Under normal conditions (no phase transients due to rearrangement) an OC-N reference signal must meet this mask at the interface point (at the equipment in the office where the timing is received). (See T1.101-1994, 7.3.1.1)

MTIE DS1 Interface

Under normal conditions (no phase transients due to rearrangement) a DS1 reference signal must meet this mask at the interface point (at the DSX-1 cross-connect in the node receiving timing). (See T1.101-1994, 7.2.1.1)

MTIE Derived DS1

The DS1 timing reference derived by a SONET network element from an OC-N signal must meet this mask. (See GR-253-CORE, 5.4.5.1)

MTIE PRS Output

The output of a Primary Reference Source or a Stratum 1 clock must meet this mask. (See GR-2830-CORE and T1.101-1994, Sect. 6.)

MTIE SMC Holdover

When a Synchronous Equipment Clock enters holdover, the transient during the first 64 seconds shall have an MTIE relative to the (wanderless) input that meets this mask. (See T1.105.09, Section 7.2.)

MTIE SMC Transient

A SONET Minimum Clock (SMC), as measured at the OC-N or STS-N signal out of a SONET network element, must meet this mask during synchronization rearrangement operations. (See GR-253-CORE, Section 5.4.4.3.3.)

TDEV OC-N Generation

An OC-N or STSX-N signal out of a SONET network element must meet this mask when timed with a wander-free reference. The reference shall, however, have white jitter of 1 μ s p-p bandlimited from 10 Hz to 150 Hz. (see GR-253-CORE, 5.4.4.3.1.)

An DS1 signal out of a stratum clock must meet this mask when timed with a wander-free reference. The reference shall, however, have white jitter of 1 μ s p-p bandlimited from 10 Hz to 150 Hz. (see GR-1244-CORE, 5.3.)

TDEV OC-N Interface

Under normal conditions (no phase transients due to rearrangement) an OC-N reference signal must meet this mask at the interface point (at the equipment in the office where the timing is received). (See T1.101-1994, 7.3.2)

An OC-N or STSX-N signal out of a SONET network element must meet the “OC-N Interface” TDEV mask when referenced to a DS1 timing signal that meets the “DS1 Filtered” TDEV mask. An OC-N or STSX-N signal out of a SONET network element must meet the “OC-N Interface” TDEV mask when referenced to a line OC-N timing signal that meets the “OC-N Interface” TDEV mask. (See GR-253, 5.4.4.2.4)

TDEV DS1 Interface

Under normal conditions (no phase transients due to rearrangement) a DS1 reference signal must meet this mask at the interface point (at the DSX-1 cross-connect in the node receiving timing). (See T1.101-1994, 7.2.2)

TDEV DS1 Filtered

A filtered DS1 timing reference input to a SONET network element must meet this mask. (Implied by GR-253-CORE, 5.4.4.2.4)

TDEV Derived DS1

The DS1 timing reference derived by a SONET network element from an OC-N signal must meet this mask. (See GR-253-CORE, 5.4.5.1.)

TDEV Stratum 2 & 3E

The output of a Stratum 2 or Stratum 3E clock must meet this mask when its input meets the “DS1 Interface” TDEV mask. (See GR-1244-CORE, R5-6.)

Where Masks Apply (SDH)

MTIE SEC Generation

When the Synchronous Equipment Clock is slaved to a wanderless timing source, the wander at output of the host SDH network element must meet this mask. The test is to be performed over the temperature range specified for the equipment. (See ITU-T Recommendation G.813, section 7.1.)

MTIE SEC Gen Const Temp

When the Synchronous Equipment Clock is slaved to a wanderless timing source, the wander at output host SDH network element must meet this mask. This test is to be performed at a constant temperature $\pm 1^\circ\text{K}$. (See ITU-T Recommendation G.813, section 7.1.)

MTIE SEC Tolerance

An SEC slaved to a timing source must tolerate wander on that source that (in the worst case) just meets this mask. (See ITU-T Recommendation G.813, section 8.1.) “Tolerate” means

- Maintaining the clock within prescribed performance limits. The exact performance limits are for further study.
- Not cause any alarms.
- Not cause the clock to switch reference.
- Not cause the clock to go into holdover.

MTIE SSU Tolerance

An SSU must tolerate (give no indication of improper operation) wander at its input that has MTIE of this mask. (See ETS DE/TM 3017-4, section 7.2.)

MTIE PRC Output

The wander at the output of a Primary Reference Clock must meet this mask. (See ETS DE/TM 3017-3, section 7.2.1.)

MTIE SSU Output

The wander at the output of a Synchronisation Supply Unit (slave clock) anywhere in the network must meet this mask. (See ETS DE/TM 3017-3, section 7.2.2.)

MTIE SEC Output

The wander at the output of a Synchronous Equipment Clock (output of a SDH network element) anywhere in the network must meet this mask. (See ETS DE/TM 3017-3, section 7.2.3.)

MTIE PDH Output

The wander at the output of a PDH equipment providing a 2 Mbit/s synchronisation signal anywhere in the network must meet this mask. (See ETS DE/TM 3017-3, section 7.2.4.)

MTIE PRC Generation

The wander at the output of a Primary Reference Clock must meet this mask. The reference used in making this measurement must be more stable than the requirements of the mask. (See ETS DE/TM 3017-6, section 5.1.)

MTIE SSU Generation

The wander at the output of a Synchronisation Supply Unit must meet this mask when the reference to the SSU is ideal (at least 10 times more stable than the output requirements). (See ETS DE/TM 3017-4, section 6.1.)

MTIE SEC Transient

The transient out of an SEC due to an up-steam switch is restricted. The specification is given in words rather than by an MTIE mask (see ETS DE/TM 3017-5, section 9.1 and ITU-T Recommendation G.813, section 10.1.) Note that TIE plot referred to in the specification is not an MTIE mask; it is only a summary of the transient specification. Meeting the MTIE mask provided here is a necessary but not sufficient condition for meeting the transient specification.

TDEV SEC Gen Const Temp

When the Synchronous Equipment Clock is slaved to a wanderless timing source, the wander at the output of the host SDH network element must meet this mask. This test is to be performed at a constant temperature $\pm 1^\circ\text{K}$. (See ITU-T Recommendation G.813, section 7.1.)

TDEV SEC Tolerance

An SEC slaved to a timing source must tolerate wander on that source that (in the worst case) just meets this mask. (See ITU-T Recommendation G.813, section 8.1.) “Tolerate” means

- Maintaining the clock within prescribed performance limits. The exact performance limits are for further study.
- Not cause any alarms.
- Not cause the clock to switch reference.
- Not cause the clock to go into holdover.

TDEV SSU Tolerance

An SSU must tolerate (give no indication of improper operation) wander at its input that has TDEV of this mask. (See ETS DE/TM 3017-4, section 7.2.)

TDEV SSU Transfer

The wander at the output of a Synchronisation Supply Unit must meet this mask when the reference to the SSU has TDEV equal to the SSU Tolerance mask. (See ETS DE/TM 3017-4, section 8.)

TDEV PRC Output

The wander at the output of a Primary Reference Clock must meet this mask. (See ETS DE/TM 3017-3, section 7.2.1.)

TDEV SSU Output

The wander at the output of a Synchronisation Supply Unit (slave clock) anywhere in the network must meet this mask. (See ETS DE/TM 3017-3, section 7.2.2.)

TDEV SEC Output

The wander at the output of a Synchronous Equipment Clock (output of a SDH network element) anywhere in the network must meet this mask. (See ETS DE/TM 3017-3, section 7.2.3.)

TDEV PDH Output

The wander at the output of a PDH equipment providing a 2 Mbit/s synchronisation signal anywhere in the network must meet this mask. (See ETS DE/TM 3017-3, section 7.2.4.)

TDEV PRC Generaton

The wander at the output of a Primary Reference Clock providing a 2 Mbit/s synchronisation signal must meet this mask. The reference used in making this measurement must be more stable than the requirements of the mask. (See ETS DE/TM 3017-6, section 5.1.)

TDEV SSU Generation

The wander at the output of a Synchronisation Supply Unit must meet this mask when the reference to the SSU is ideal (at least 10 times more stable than the output requirements). (See ETS DE/TM 3017-4, section 6.1.)

TDEV and MTIE (SDH Standards)

This appendix details the Time Deviation (TDEV) and Maximum Time Interval Error (MTIE) standards for the SDH Equipment and the SDH Networks.

The masks in this section were used in Version 5.0 of the Wander Analyst software.

MTIE Masks (SDH Equipment)

MTIE SEC Generation

When the Synchronous Equipment Clock is slaved to a wanderless timing source, the wander at output of the host SDH network element must meet this mask. The test is to be performed over the temperature range specified for the equipment. (See ITU-T Recommendation G.813, section 7.1.)

SEC Generation (ITU-T, Fig. 1/G.813)

$$\begin{aligned} \text{MTIE} &= 40 + 0.5\tau & 0.1 < \tau \leq 1 \\ \text{MTIE} &= 40\tau^{0.1} + 0.5\tau & 1 < \tau \leq 100 \\ \text{MTIE} &= 25.25\tau^{0.2} + 50 & 100 < \tau \leq 1000 \end{aligned}$$

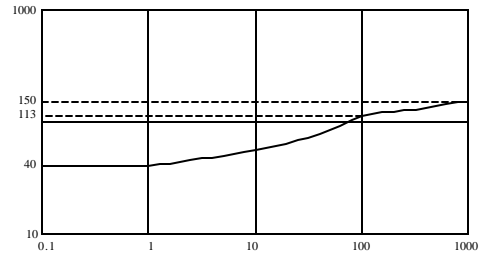

MTIE SEC Gen Const Temp

When the Synchronous Equipment Clock is slaved to a wanderless timing source, the wander at output host SDH network element must meet this mask. This test is to be performed at a constant temperature ±1°K. (See ITU-T Recommendation G.813, section 7.1.)

SEC Gen Const Temp (ITU-T, Fig. 1/G.813)

$$\begin{aligned} \text{MTIE} &= 40 & 0.1 < \tau \leq 1 \\ \text{MTIE} &= 40\tau^{0.1} & 1 < \tau \leq 100 \\ \text{MTIE} &= 25.25\tau^{0.2} & 100 < \tau \leq 1000 \end{aligned}$$

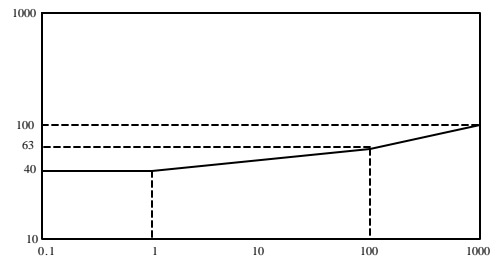

MTIE SEC Tolerance

An SEC slaved to a timing source must tolerate wander on that source that (in the worst case) just meets this mask. (See ITU-T Recommendation G.813, section 8.1.) “Tolerate” means:

- Maintaining the clock within prescribed performance limits. The exact performance limits are for further study.
- Not cause any alarms.
- Not cause the clock to switch reference.
- Not cause the clock to go into holdover.

SEC Tolerance (ITU-T, Fig. 5/G.813)

MTIE = 250	$0.1 < \tau \leq 2.5$
MTIE = 100 τ	$2.5 < \tau \leq 20$
MTIE = 2000	$20 < \tau \leq 400$
MTIE = 5 τ	$400 < \tau \leq 1000$

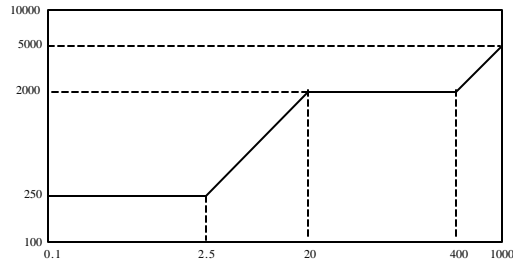

MTIE SSU Tolerance

An SSU must tolerate (give no indication of improper operation) wander at its input that has MTIE of this mask. (See ETS DE/TM 3017-4, section 7.2.)

SSU Tolerance (ETS DE/TM-3017-4, Fig. 5)

MTIE = 750	$0.1 < S \leq 7.5$
MTIE = 100 S	$7.5 < S \leq 20$
MTIE = 2000	$20 < S \leq 400$
MTIE = 5 S	$400 < S < 1000$
MTIE = 5000	$1000 < S < 10^4$

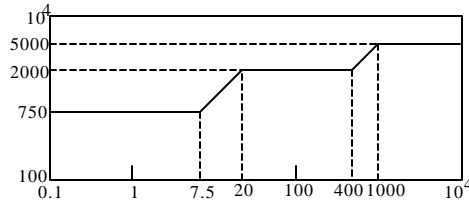

MTIE SSU Generation

The wander at the output of a Synchronisation Supply Unit must meet this mask when the reference to the SSU is ideal (at least 10 times more stable than the output requirements). (See ETS DE/TM 3017-4, section 6.1.)

SSU Generation (ETS DE/TM-3017-4, Fig.2)
 MTIE = 24 $0.1 < S < 9$
 MTIE = $8 S^{0.5}$ $9 < S < 400$
 MTIE = 160 $400 < S < 1000$

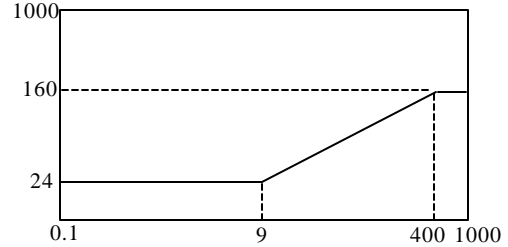

MTIE SEC Holdover

When a Synchronous Equipment Clock enters holdover, the transient during the first 64 seconds shall have an MTIE relative to the (wanderless) input that meets this mask. (See ITU G.813, Sect. 10.2b.)

SEC Holdover (ITU G.813, Fig. 15)
 MTIE = $7.6 + 885S$ $0.014 < S < 0.5$
 MTIE = $300 + 300S$ $0.5 < S < 2.33$
 MTIE = $884 + 50S$ $2.33 < S < 64$

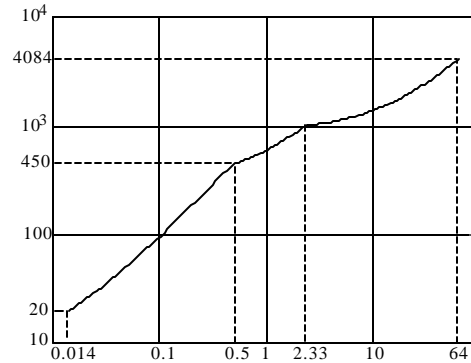

MTIE SEC Transient

The transient out of an SEC due to an up-stream switch is restricted. The specification is given in words rather than by an MTIE mask (see ETS DE/TM 3017-5, section 9.1 and ITU-T Recommendation G.813, section 10.1.) Note that TIE plot referred to in the specification is not an MTIE mask; it is only a summary of the transient specification. Meeting the MTIE mask provided here is a necessary but not sufficient condition for meeting the transient specification.

SEC Transient (ITU G.813, Fig.12)
 (ETS DE/TM 3017-5, Fig. 7)

MTIE = 7500S	$0.001 < S < 0.032$
MTIE = 238.4 + 50S	$0.032 < S < 15$
MTIE = 1000	$15 < S < 1000$

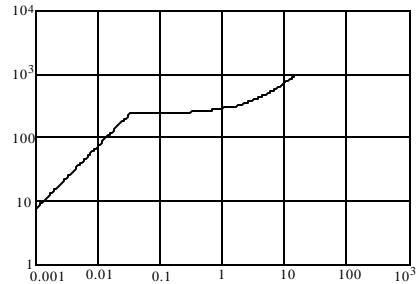

MTIE PRC Noise Generation

The wander at the output of a Primary Reference Clock must meet this mask. The reference used in making this measurement must be more stable than the requirements of the mask. (See ETS DE/TM 3017-6, section 5.1.)

PRC Generation (ETS DE/TM-3017-6, Fig. 1)

MTIE = 25 + 0.275S	$0.1 < S < 1000$
MTIE = 290 + 0.01S	$1000 < S$

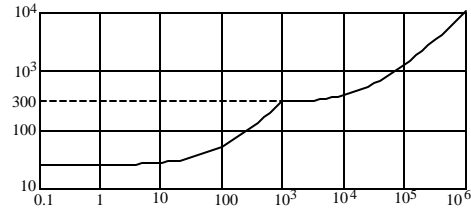

MTIE Masks (SDH Network)

MTIE PRC Output

The wander at the output of a Primary Reference Clock must meet this mask.
(See ETS DE/TM 3017-3, section 7.2.1.)

PRC Output (ETS DE/TM-3017-3, Fig. 3)

MTIE = 25	$0.1 < S \leq 83$
MTIE = $0.3S$	$83 < S \leq 1000$
MTIE = 300	$1000 < S \leq 30000$
MTIE = $0.01S$	$30000 < S$

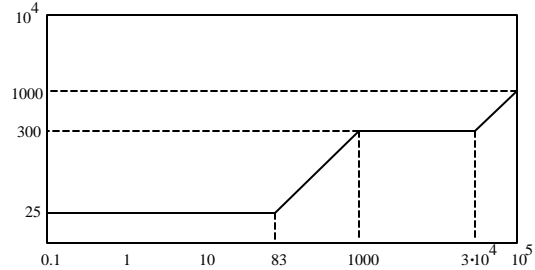

MTIE SSU Output

The wander at the output of a Synchronisation Supply Unit (slave clock) anywhere in the network must meet this mask.
(See ETS DE/TM 3017-3, section 7.2.2.)

SSU Output (ETS DE/TM-3017-3, Fig. 5)

MTIE = 25	$0.1 < S \leq 2.5$
MTIE = $10S$	$2.5 < S \leq 200$
MTIE = 2000	$200 < S \leq 2000$
MTIE = $433S^{0.2} + 0.01S$	$2000 < S$

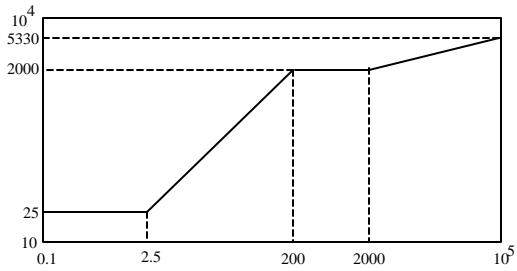

MTIE SEC Output

The wander at the output of a Synchronous Equipment Clock (output of a SDH network element) anywhere in the network must meet this mask.

(See ETS DE/TM 3017-3, section 7.2.3.)

SEC Output (ETS DE/TM-3017-3, Fig. 7)

MTIE = 250	$0.1 < S \leq 2.5$
MTIE = 100S	$2.5 < S \leq 20$
MTIE = 2000	$20 < S \leq 2000$
MTIE = $433S^{0.2} + 0.01S$	$2000 < S$

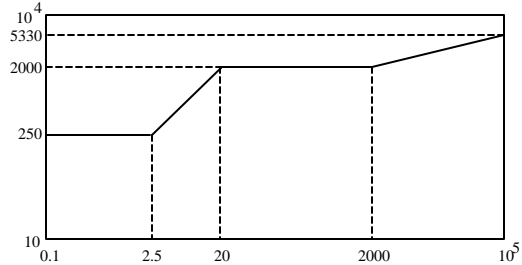

MTIE PDH Output

The wander at the output of a PDH equipment providing a 2 Mbit/s synchronisation signal anywhere in the network must meet this mask.

(See ETS DE/TM 3017-3, section 7.2.4.)

PDH Output (ETS DE/TM-3017-3, Fig. 9)

MTIE = 732	$0.1 < S \leq 7.3$
MTIE = 100S	$7.3 < S \leq 20$
MTIE = 2000	$20 < S \leq 2000$
MTIE = $433S^{0.2} + 0.01S$	$2000 < S$

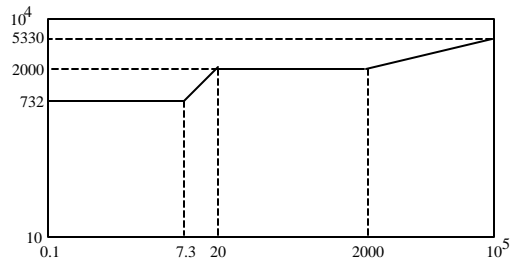

TDEV Masks (SDH Equipment)

TDEV SEC Gen Const Temp

When the Synchronous Equipment Clock is slaved to a wanderless timing source, the wander at the output of the host SDH network element must meet this mask.

This test is to be performed at a constant temperature $\pm 1^\circ\text{K}$.

(See ITU-T Recommendation G.813, section 7.1.)

SEC Gen Const Temp (ITU-T, Fig.2/G.813)

TDEV = 32	$0.1 < \tau \leq 25$
TDEV = $0.64\tau^{0.5}$	$25 < \tau \leq 100$
TDEV = 64	$100 < \tau \leq 1000$

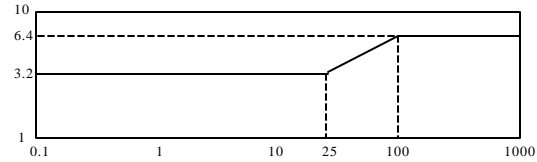

TDEV SEC Tolerance

An SEC slaved to a timing source must tolerate wander on that source that (in the worst case) just meets this mask. (See ITU-T Recommendation G.813, section 8.1.) “Tolerate” means:

- Maintaining the clock within prescribed performance limits. The exact performance limits are for further study.
- Not cause any alarms.
- Not cause the clock to switch reference.
- Not cause the clock to go into holdover.

SEC Tolerance (ITU-T, Fig. 6/G.813)

TDEV = 12	$0.1 < \tau \leq 7$
TDEV = 1.7τ	$7 < \tau \leq 100$
TDEV = 170	$100 < \tau \leq 400$

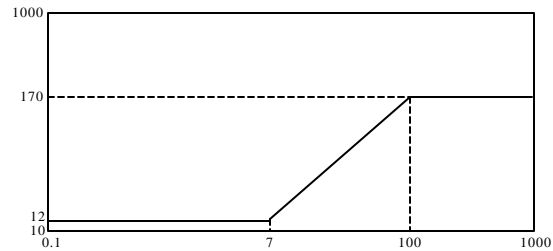

TDEV SSU Tolerance

An SSU must tolerate (give to indication of improper operation) wander at its input that has TDEV of this mask. (See ETS DE/TM 3017-4, section 7.2.)

SSU Tolerance (ETS DE/TM-3017-4, Fig. 4)

TDEV = 34	$0.1 < \tau \leq 20$
TDEV = 1.7τ	$20 < \tau \leq 100$
TDEV = 170	$100 < \tau \leq 1000$
TDEV = $5.4\tau^{0.5}$	$1000 < \tau \leq 10^4$

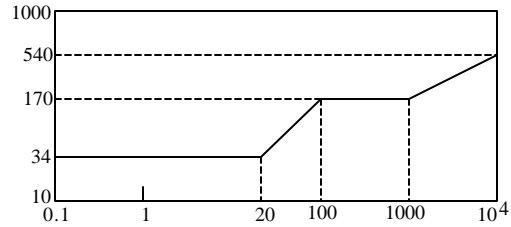

TDEV SSU Transfer

The wander at the output of a Synchronisation Supply Unit must meet this mask when the reference to the SSU has TDEV equal to the SSU Tolerance mask. (See ETS DE/TM 3017-4, section 8.)

SSU Transfer (ETS DE/TM-3017-4, Fig. 7)

TDEV = 3	$0.1 < \tau \leq 13.3$
TDEV = $0.017\tau^2$	$13.3 < \tau \leq 100$
TDEV = 170	$100 < \tau \leq 1000$
TDEV = $5.4\tau^{0.5}$	$1000 < \tau \leq 10^4$

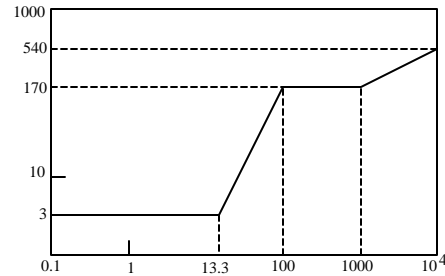

TDEV SSU Generation

The wander at the output of a Synchronisation Supply Unit must meet this mask when the reference to the SSU is ideal (at least 10 times more stable than the output requirements). (See ETS DE/TM 3017-4, section 6.1.)

SSU Generation (ETS DE/TM-3017-4, Fig.1)

TDEV = 3	$0.1 < \tau < 25$
TDEV = 0.12τ	$25 < \tau < 100$
TDEV = 12	$100 < \tau < 1000$

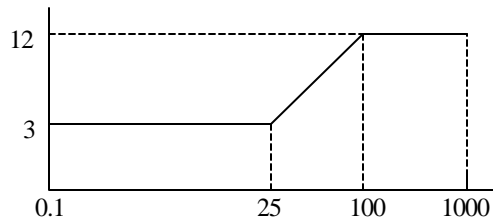

TDEV PRC Noise Generation

The wander at the output of a Primary Reference Clock providing a 2 Mbit/s synchronisation signal must meet this mask. The reference used in making this measurement must be more stable than the requirements of the mask.
(See ETS DE/TM 3017-6, section 5.1.)

PRC Generation (ETS DE/TM-3017-6, Fig.2)
TDEV = 3 $0.1 < S < 100$
TDEV = $0.03S$ $100 < S < 1000$
TDEV = 30 $1000 < S < 10^4$

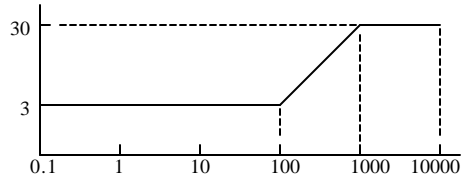

TDEV Masks (SDH Network)

TDEV PRC Output

The wander at the output of a Primary Reference Clock must meet this mask.
(See ETS DE/TM 3017-3, section 7.2.1.)

PRC Output (ETS DE/TM-3017-3, Fig. 4)

TDEV = 3	$0.1 < S \leq 100$
TDEV = $0.03S$	$100 < S \leq 1000$
TDEV = $29.7 + 0.0003S$	$1000 < S < 10^6$

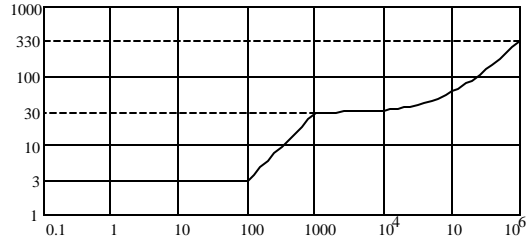

TDEV SSU Output

The wander at the output of a Synchronisation Supply Unit (slave clock) anywhere in the network must meet this mask.
(See ETS DE/TM 3017-3, section 7.2.2.)

SSU Output (ETS DE/TM-3017-3, Fig. 6)

TDEV = 3	$0.1 < S \leq 4.3$
TDEV = $0.7S$	$4.3 < S \leq 100$
TDEV = $58 + 1.2S^{0.5} + 0.0003S$	$100 < S < 10^6$

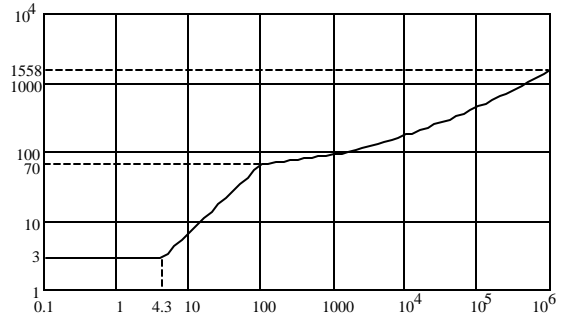

TDEV SEC Output

The wander at the output of a Synchronous Equipment Clock (output of a SDH network element) anywhere in the network must meet this mask.

(See ETS DE/TM 3017-3, section 7.2.3.)

SEC Output (ETS DE/TM-3017-3, Fig. 8)

$$\begin{aligned} \text{TDEV} &= 12 & 0.1 < S \leq 17.14 \\ \text{TDEV} &= 0.7S & 17.14 < S \leq 100 \\ \text{TDEV} &= 58 + 1.2S^{0.5} + 0.0003S & 100 < S < 10^6 \end{aligned}$$

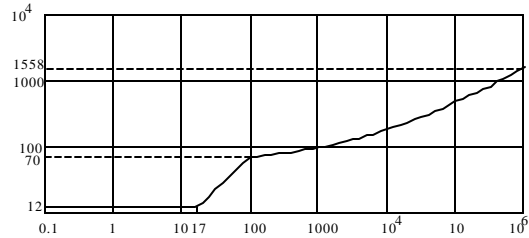

TDEV PDH Output

The wander at the output of a PDH equipment providing a 2 Mbit/s synchronisation signal anywhere in the network must meet this mask.

(See ETS DE/TM 3017-3, section 7.2.4.)

PDH Output (ETS DE/TM-3017-3, Fig. 10)

$$\begin{aligned} \text{TDEV} &= 34 & 0.1 < S \leq 48 \\ \text{TDEV} &= 0.7S & 48 < S \leq 100 \\ \text{TDEV} &= 58 + 1.2S^{0.5} + 0.0003S & 100 < S < 10^6 \end{aligned}$$

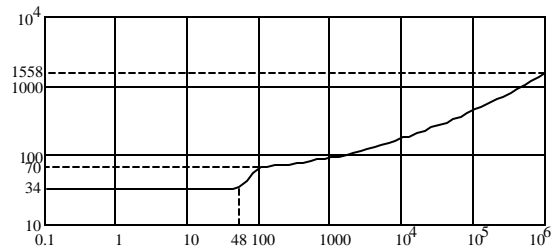

TDEV and MTIE (SONET Standards)

This appendix details the Time Deviation (TDEV) and Maximum Time Interval Error (MTIE) standards for the SONET Equipment and the SONET Networks. The masks in this section were used in Version 5.0 of the Wander Analyst software.

MTIE Masks (SONET Equipment)

MTIE OC-N Transient

An OC-N or STSX-N signal out of a SONET network element must meet this mask during synchronization rearrangement operations.

(See GR-253-CORE, 5.4.4.3.2 and T1.101-1994, 7.3.1.2)

OC-N Transient (GR-253-CORE, Fig. 5-18)
(T1.101-1994, Fig. 8)

$MTIE = 76 + 88S$	$0.014 \leq S < 0.5$
$MTIE = 30 + 30S$	$0.5 \leq S < 2.33$
$MTIE = 100$	$2.33 \leq S < 280$
$MTIE = 997 + 00S$	$280 \leq S \leq 10^6$

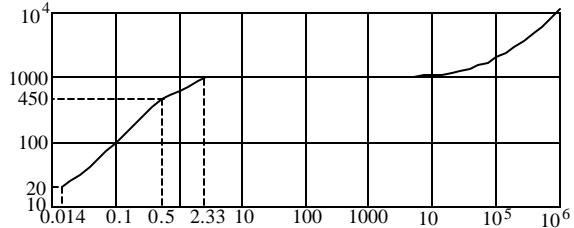

MTIE OC-N Generation

An OC-N or STSX-N signal out of a SONET network element must meet this mask when timed with a wander-free reference. The reference shall, however, have white jitter of 1 μ s p-p band-limited from 10 Hz to 150 Hz.

(see GR-253-CORE, 5.4.4.3.1.)

OC-N Generation (GR-253-CORE, Fig. 5-16)

$MTIE = 20$	$0.1 \leq S < 1$
$MTIE = 20 * S^{0.48}$	$1 \leq S < 10$
$MTIE = 60$	$10 \leq S \leq 1000$

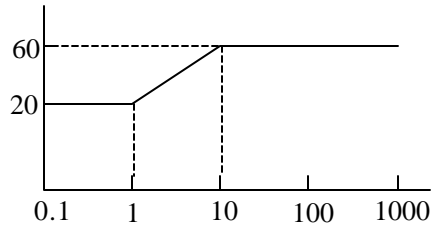

MTIE Derived DS1

The DS1 timing reference derived by a SONET network element from an OC-N signal must meet this mask. (See GR-253-CORE, 5.4.5.1)

Derived DS1 (GR-253-CORE, **R5-151**)

$MTIE = 50$	$0.1 \leq S \leq 1000$
-------------	------------------------

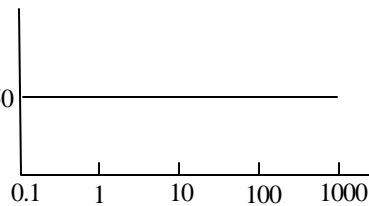

MTIE DS1 Generation

The output of a stratum 2,3, or 3E clock must meet this mask when timed with a wander-free reference. The reference shall, however, have white jitter of 1 μ s p-p band-limited from 10 Hz to 150 Hz. (see GR-1244-CORE, R5-5.)

DS1 Generation (GR-1244-CORE, Fig. 5-2)
 MTIE = 40 $0.1 \leq S < 1$
 MTIE = $40 * S^{0.4}$ $1 \leq S < 10$
 MTIE = 100 $10 \leq S \leq 1000$

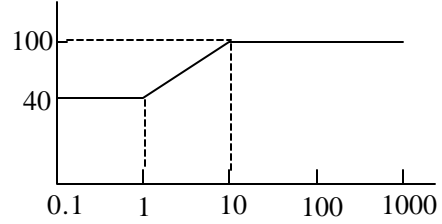

MTIE Masks (SONET Network)

MTIE OC-N Interface

Under normal conditions (no phase transients due to rearrangement) an OC-N reference signal must meet this mask at the interface point (at the equipment in the office where the timing is received). (See T1.101-1994, 7.3.1.1)

OC-N Interface (T1.101-1994, Fig. 7)

$$\begin{aligned} \text{MTIE} &= 70 + 3.32 * S & 0.05 \leq S < 280 \\ \text{MTIE} &= 997 + 0.01 * S & 280 \leq S \leq 10^6 \end{aligned}$$

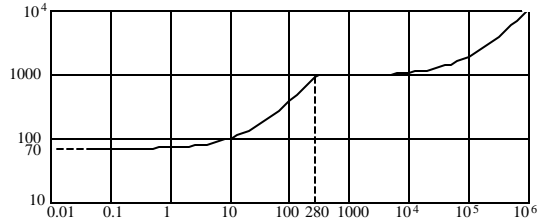

MTIE DS1 Interface

Under normal conditions (no phase transients due to rearrangement) a DS1 reference signal must meet this mask at the interface point (at the DSX-1 cross-connect in the node receiving timing). (See T1.101-1994, 7.2.1.1)

DS1 Interface (T1.101-1994, Fig. 5)

$$\begin{aligned} \text{MTIE} &= 300 + 2.5 * S & 0.05 \leq S < 280 \\ \text{MTIE} &= 997 + 0.01 * S & 280 \leq S \leq 10^6 \end{aligned}$$

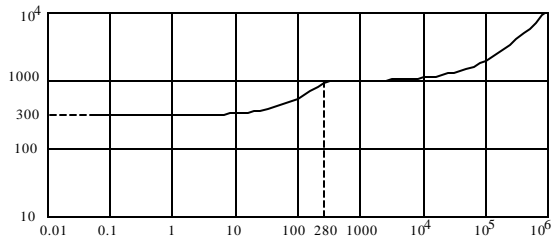

MTIE PRS Output

The output of a Primary Reference Source or a Stratum 1 clock must meet this mask. (See GR-2830-CORE and T1.101-1994, Sect. 6.)

PRS Output (T1.101-1994, Fig. 4)
(GR-2830-CORE)

$MTIE = 10 + 0.29 * S$	$0.05 \leq S < 1000$
$MTIE = 290 + 0.01 * S$	$1000 \leq S$

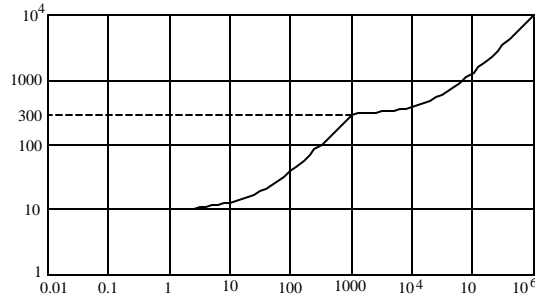

MTIE SMC Transient

A SONET Minimum Clock (SMC), as measured at the OC-N or STS-N signal out of a SONET network element, must meet this mask during synchronization rearrangement operations. (See GR-253-CORE, Section 5.4.4.3.3.)

SMC Transient (GR-253-CORE,
Fig. 5-19)

$MTIE = 7.6 + 885S$	$0.014 < S < 0.5$
$MTIE = 300 + 300S$	$0.5 < S < 2.33$
$MTIE = 1000$	$2.33 < S < 280$

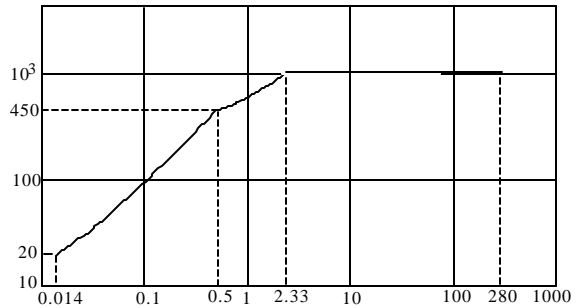

TDEV Masks (SONET Equipment)

TDEV OC-N Generation

An OC-N or STSX-N signal out of a SONET network element must meet this mask when timed with a wander-free reference. The reference shall, however, have white jitter of 1 μ s p-p and a band-limited from 10 Hz to 150 Hz. (see GR-253-CORE, 5.4.4.3.1.)

An DS1 signal out of a stratum clock must meet this mask when timed with a wander-free reference. The reference shall, however, have white jitter of 1 μ s p-p band-limited from 10 Hz to 150 Hz. (see GR-1244-CORE, 5.3.)

OC-N Generation (GR-253-CORE, Fig. 5-17)
(GR-1244-CORE, Fig. 5-1)

$TDEV = 3.2 * t^{0.5}$	$0.1 \leq t < 2.5$
$TDEV = 2$	$2.5 \leq t < 40$
$TDEV = 0.32 * t^{0.5}$	$40 \leq t < 1000$
$TDEV = 10$	$1000 \leq t \leq 10^4$

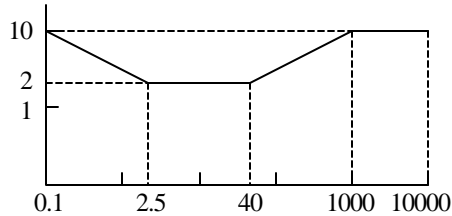

TDEV Derived DS1

The DS1 timing reference derived by a SONET network element from an OC-N signal must meet this mask. (See GR-253-CORE, 5.4.5.1.)

Derived DS1 (GR-253-CORE, Fig. 5-21)

$TDEV = 3.2 * t^{0.5}$	$0.1 \leq t < 2.5$
$TDEV = 2$	$2.5 \leq t \leq 1000$

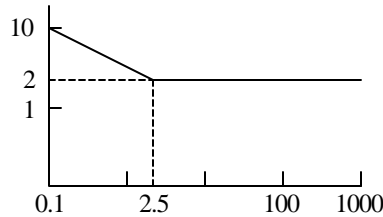

TDEV DS1 Filtered

A filtered DS1 timing reference input to a SONET network element must meet this mask. (Implied by GR-253-CORE, 5.4.4.2.4)

DS1 Filtered (GR-253-CORE, Fig. 5-15)
 $TDEV = 17$ $0.1 \leq t < 3$
 $TDEV = 5.67 * t$ $3 \leq t < 30$
 $TDEV = 31.62 * t^{0.5}$ $30 \leq t \leq 1000$

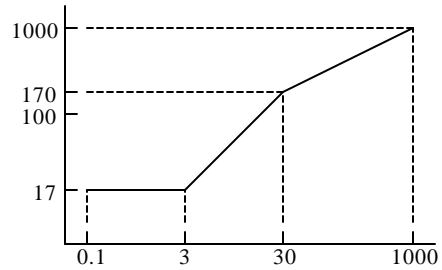

TDEV Stratum 2 & 3E

The output of a Stratum 2 or Stratum 3E clock must meet this mask when its input meets the “DS1 Interface” TDEV mask. (See GR-1244-CORE, R5-6.)

Stratum 2 & 3E (GR-1244-CORE, Fig. 5-3)
 $TDEV = 2$ $0.05 \leq t < 0.347$
 $TDEV = 5.77 * t$ $0.347 \leq t < 30$
 $TDEV = 31.6 * t^{0.5}$ $30 \leq t < 1000$

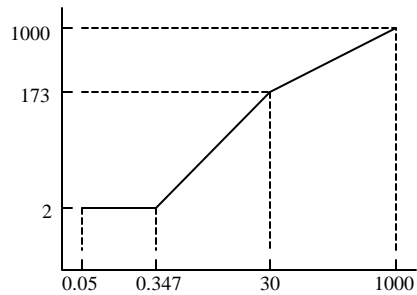

TDEV Masks (SONET Network)

TDEV OC-N Interface

Under normal conditions (no phase transients due to rearrangement) an OC-N reference signal must meet this mask at the interface point (at the equipment in the office where the timing is received). (See T1.101-1994, 7.3.2)

An OC-N or STSX-N signal out of a SONET network element must meet the “OC-N Interface” TDEV mask when referenced to a DS1 timing signal that meets the “DS1 Filtered” TDEV mask. An OC-N or STSX-N signal out of a SONET network element must meet the “OC-N Interface” TDEV mask when referenced to a line OC-N timing signal that meets the “OC-N Interface” TDEV mask. (See GR-253, 5.4.4.2.4)

OC-N Interface (T1.101-1994, Fig. 9)
(GR-253, Fig. 5-14)

TDEV = 10	$0.05 \leq t < 1.73$
TDEV = $5.77 * t$	$1.73 \leq t < 30$
TDEV = $31.6 * t^{0.5}$	$30 \leq t \leq 1000$

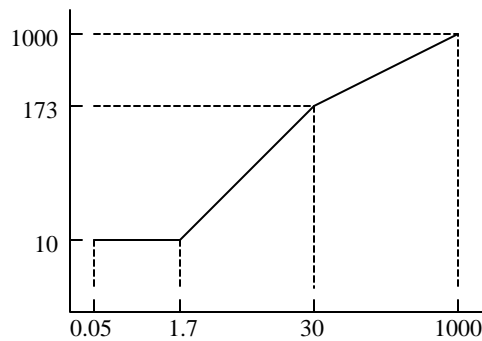

TDEV DS1 Interface

Under normal conditions (no phase transients due to rearrangement) a DS1 reference signal must meet this mask at the interface point (at the DSX-1 cross-connect in the node receiving timing). (See T1.101-1994, 7.2.2)

DS1 Interface (T1.101-1994, Fig. 6)

TDEV = 100	$0.05 \leq t < 10$
TDEV = $31.6 * t^{0.5}$	$10 \leq t \leq 1000$

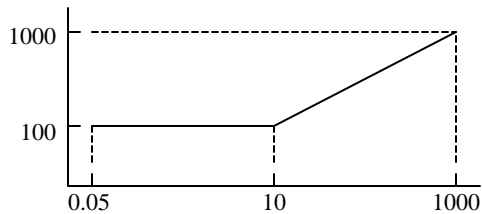

Index

- Applications, 2-4
 - Basic Wander Measurement, 2-4
 - Generating Phase Transients, 2-6
 - Phase Transient Conformance Testing, 2-8
 - OC-N Phase Transient Test, 2-8
 - Synch Clock Transient Test, 2-10
 - Wander measurements displayed, 2-5
 - Wander Transfer Conformance Testing, 2-12
 - Wander Transfer Specifications, 2-12
 - Transfer from DS1 to OC-N, 2-12
 - Transfer from OC-N to OC-N, 2-13
- Hardware Requirements, 1-6
 - Personal Computer, 1-6
 - SDH/SONET Analyzer, 1-6
- Keyboard Operation without a Mouse, 1-24
- Masks
 - Standards, SONET - TDEV and MTIE, (Version 5.0), B-1
 - Standards, SDH - TDEV and MTIE, (Version 5.0), C-1
 - Wander (Version 6.0), A-1
- Menus
 - Communication Selection, 1-12
 - Uploading Data Setup, 1-13
 - Upload Configuration Menu, 1-13
 - Uploading Data from the test set, 1-14
 - Graphic Displays, 1-15
 - Port Setup, 1-12
 - File Selection, 1-11
 - Help Selection, 1-23
 - Mask Menu, 1-18
 - MTIE mask choices, 1-20
 - TDEV mask choices, 1-21
 - Plot Menu, 1-16
 - Process Data Menu, 1-22
- Operating Basics, 1-7
 - Distribution Diskette Contents, 1-7
 - GPIB Port Setup, 1-8
 - Installation Procedure, 1-7
 - Port Configuration, 1-8
 - Program Configuration, 1-8
 - Program First Start, 1-10
 - Program Startup, 1-9
 - Program Startup, 1-9
 - RS-232 Port Setup, 1-8
 - Software Installation, 1-7
- Software, 1-2
 - Display & User Interface, 1-3
 - Program Overview, 1-2
 - Changes from Previous Versions, 1-4
- Specifications, 1-4
 - SDH conformance test, 1-4
 - Software; 1-5
 - SONET conformance test, 1-5
- Technical Articles, 2-16
 - Consequences of Jitter/Wander in Network, 2-18
 - New issues, Timing and Synch, 2-17
 - Principles & Metrics of Jitter/Wander, 2-32
 - Testing for Jitter and Wander, 2-19
 - Video Transport, Broadband Networks, 2-17
- Test Functions, Wander, 2-2
 - Calculate MTIE, 2-3
 - Calculate TDEV, 2-3
 - Generate Wander and Jitter References, 2-2
 - Measure DS1 Wander Relative to Reference, 2-3
 - Measure SONET/SDH Wander Relative to Reference, 2-3
 - Pure Clock Signal, 2-2
- Zoom, In, Zoom Out, Full, 1-24

