



Optical Wavelength Manager Quick Start Guide

Software Version:	2.1.0
Part Number:	9-0206-05567-01
Part Number Revision:	01
Release Date:	December 2002

Copyright Information

All information, whether text or graphics, contained in this manual is confidential and proprietary information of Digital Lightwave™ Inc. All such information is protected by copyright laws and international treaties. No part of this manual may be reproduced or transmitted in any form or by any means, electronic, mechanical or otherwise for any purpose without the express written permission of Digital Lightwave™ Inc. The possession, viewing or use of the information contained in this manual does not transfer any intellectual property rights or grant a license to use this information or any software application referred to herein for any purpose other than that for which it was provided. The information in this document is subject to change without notice. Although every effort has been made to make this document as accurate, complete and clear as possible, Digital Lightwave™ Inc. and its predecessors assume no responsibility for any errors that may appear in this document.

Trademarks

Agilent is a registered trademark of Agilent Technologies, Inc.®

CLETOP is a registered trademark of NTT International Co. Ltd.®

HP is a registered trademark of Hewlett Packard Company.®

HyperTerminal is a registered trademark of Hilgraeve, Inc.

IBM is a registered trademark of International Business Machines Corporation.®

InstallAnywhere is a registered trademark of Zero G Software, Inc.®

Java is a trademark of Sun Microsystems™, Inc.

Digital Lightwave is a trademark of Digital Lightwave™, Inc.

Linux is a registered trademark of Linus Torvalds®.

MS-DOS is a registered trademark of Microsoft Corporation®.

Pentium is a registered trademark of Intel Corporation®.

Solaris and SPARC are registered trademarks of Sun Microsystems, Inc.®

Texwipe is a register trademark of ITW Texwipe®.

UL is a registered trademark of Underwriters Laboratories Inc.®

UltraJet is a registered trademark of ITW Chemtronics®.

Windows, Windows 98, Windows Millennium Edition, Windows NT, Windows 2000 Professional, Windows XP and Microsoft are registered trademarks of Microsoft Corporation.®

All other brands, names or trademarks mentioned in this document are the property of their respective owners.

Copyright © 2000, 2001, 2002 Digital Lightwave™ Inc.

ALL RIGHTS RESERVED.

Preface

Introduction

This guide contains step-by-step instructions on how to temporarily connect a PC directly to the Digital Lightwave Optical Wavelength Manager (OWM) and begin exploring the OWM's capabilities. For a permanent connection refer to the OWM User's Guide.

This guide gives both OWM and PC instructions that will allow a novice user to perform basic configuration and communicate with the OWM.

By following this Quick Start Guide, the user will be able to configure the Optical Wavelength Manager (OWM) to perform the following functions:

- operate as a very fast Optical Spectrum Analyzer (OSA)
- create devices and channels
- create/enable device alarms

Overview

Configuration of the OWM has several dependencies and must follow a logical order. The sections within each chapter are written in the order in which they need to be executed.

The table below identifies the sequence of steps to be performed to connect a PC directly to the OWM and begin exploring the OWM capabilities.

Instruction Step	Location
Connect the Optical Fiber Cable to the OWM	Page 1-1
Configure IP Networking	Page 1-3
Install the GUI	Page 1-10
Launch the GUI	Page 1-10
Assign Port Tap Power	Page 1-10
Monitor Optical Signals in Spectrum View	Page 1-11
Define a Device	Page 2-1
Configure Device Channels Automatically	Page 2-1
Enable Alarms	Page 2-2
Activate the Device	Page 2-3
View Device Channels	Page 2-3

Equipment Required

The following equipment is required to perform basic configuration and communication with the OWM:

- a Digital Lightwave Optical Wavelength Manager (OWM)
- power supply (-48v VDC @ 0.7 amperes) available from Digital Lightwave as an option
- null modem cable
- category 5 Ethernet crossover cable to directly connect the OWM LAN port to a workstation or PC
- OWM Java GUI Application CDROM
- OWM Quick Start Guide
- fiber-optic cables equipped with SC/UPC or SC/APC type connectors for the Monitor Input ports
- tools for cleaning the fiber optic connectors (i.e. CLETOP or Texwipes TX404 soaked with isopropyl alcohol)
- optical signals accessible via optical tap on a DWDM system or via optical splitter
- a PC with a Microsoft Windows based Operating System (e.g. Windows 98, Windows 2000)
- terminal emulation software (HyperTerminal is generally included with Microsoft operating systems)
- screwdriver (phillips head or straight)

Safety Standards

This device is intended for installation in a Restricted Access Location.

Refer to the OWM User's Guide for a detailed description of safety precautions.

The Digital Lightwave Optical Wavelength Manager (OWM) complies with the following industry and regulatory standards.

Radio Frequency Devices Unintentional Radiators, Commercial Environment

FCC Part 15, Subpart B, Class A

RADIO AND TELEVISION INTERFERENCE

NOTE: This equipment has been tested and found to comply with the limits for a Class A digital device, pursuant to Part 15 of the FCC rules. These limits are designed to provide reasonable protection against harmful interference when the equipment is operated in a commercial environment. This equipment generates, uses and can radiate radio frequency energy and, if not installed and used in accordance with the instruction manual, may cause harmful interference to radio

communications. Operation of this equipment in a residential area is likely to cause harmful interference in which case the user will be required to correct the interference at his own expense.

In order to maintain compliance with FCC regulations shielded cables must be used with this equipment. Operation with non-approved equipment or unshielded cables is likely to result in interference to radio & television reception.

Rack Panel Mounting Standards (Telco 1-inch pitch hole mounting also included).

ANSI/EIA-RS-310C, IEC 297-1

CHAPTER 1

Configure the OWM for Use as an Optical Spectrum Analyzer

Introduction

Configuring the OWM for use as an Optical Spectrum Analyzer (OSA) allows optical signals to be viewed graphically. This chapter instructs the user how to establish the hardware connections necessary to connect optical fibers, system hardware for serial and network communications, assign port tap power and monitor optical signals in Spectrum view.

Connect the Optical Fiber Cable to the OWM

The OWM is capable of monitoring Dense Wavelength Division Multiplexing (DWDM) optical signals. An optical tap can be inserted into a fiber span to supply the OWM optical input signal. Various optical taps may be used, however, the OWM generally uses a 1%- 5% tap ([Figure 1](#)) coming from a DWDM system or an optical splitter.



OWM's are configured with 1, 2, 4, or 8 fiber connectors. For this temporary connection we recommend the use of "PORT 1" for single fiber applications. If you use a different port, you must configure and select the port (see "[Monitor Optical Signals in Spectrum View](#)").

The optical signal power coming into the OWM must not cause any individual channel to exceed -10 dBm (+/- 3 dB tolerance). If a broadband optical source is used at the input, the spectral power density must be held below -1 dBm/nm (+/- 3 dB tolerance). Failure to comply with these thresholds will cause saturation but will not damage the OWM.



The OWM is intended for use with DWDM optical signals and is generally connected via an optical tap. Do not connect this directly to an optical source unless you are familiar with the source's strength and operation.

It is important that the fibers be clean before the following steps are performed:

- Verify the connector type at the Monitor Input Port interface ([Figure 2 on page 1-3](#)) is compatible with the fiber connector. A (typically blue) SC/UPC port interface can only accept a SC/UPC (typically blue) fiber connector. Similarly, a green SC/APC port interface can only accept a SC/APC (typically green) fiber connector.
- Align the connector key with the notch on the port connector and insert the fiber using light pressure.

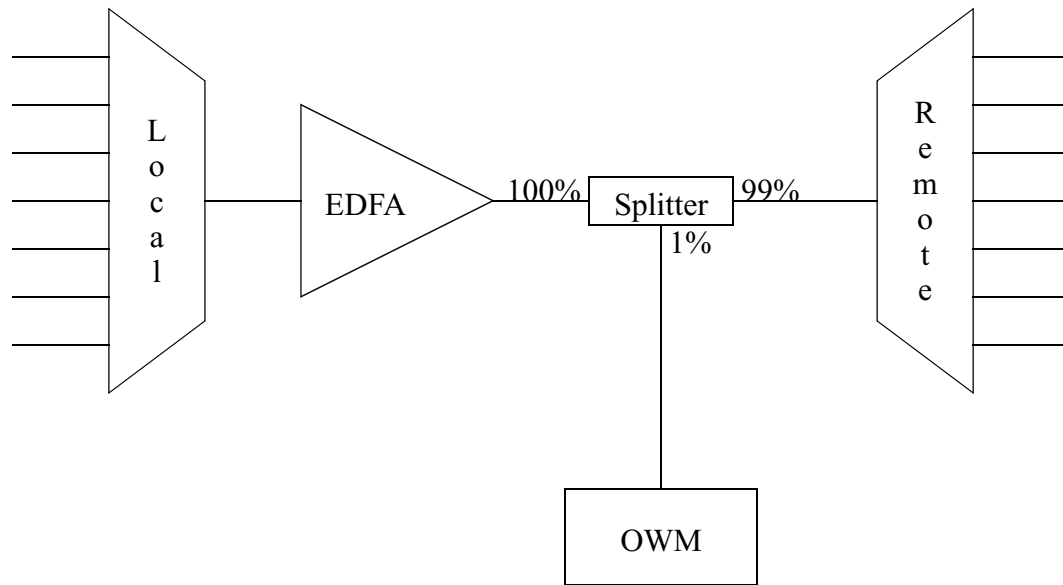

FIGURE 1. 1% Tap Power

Configure IP Networking

In order to configure IP networking, the System Hardware must be connected for serial and network communication, power connections must be made and the OWM and PC IP addresses and netmask must be set. Optionally, the IP connectivity can be verified.

Connect System Hardware

A connection to the OWM's LAN Ethernet 10baseT communications port must be established in order for any Ethernet-based functions to work (i.e. the OWM GUI, FTP, Telnet and SNMP). Either LAN port, LAN A or LAN b, can be used. The two LAN ports are connected internally through the OWM's own Ethernet hub, and are functionally equivalent.

Refer to the OWM Front Panel diagram illustrated in [Figure 2](#) for all system hardware connections.



FIGURE 2. OWM Front Panel

Connect System Hardware for Serial Communication

A connection to the OWM's RS-232 serial communications port must first be established to allow network settings (e.g. IP address) to be configured.

Here are the steps to follow:

Connect a NULL MODEM Cable

- Connect a DB9 null modem cable from your computer's COM port to the CRAFT port (DB9 female) of the OWM ([Figure 2](#)). The end of the cable connecting to the OWM must be male. The end of the cable connecting to your computer's serial communications outlet port must be appropriate for your computer. Typically this is a DB9 female.

Configure the PC's COM Port

- Configure your computer's terminal emulation software (e.g. HyperTerminal) with the following settings for the COM port you will be using.
- Using HyperTerminal will require that you assign a name to this new connection (e.g. owm). In the HyperTerminal "connect to" screen, select the "connect using" pull down screen, the appropriate COM port (e.g. COM1). In the COM1 properties screen, change the port settings to the following:

Bits per second	9600
Data bits	8
Parity	None
Stop bits	1
Flow control	None



*It is important to be sure that **Flow control** is set to **None**.*

Power Connections

To supply power to the OWM, refer to [Figure 2, “OWM Front Panel”](#) and perform the following:

- Unscrew and remove the two phillips head screws on plastic housing covering the terminal block.
- Remove the plastic housing
- Loosen the 4 slotted phillips head screws on the terminal block.
- Connect the appropriate terminal connectors to the screws on the terminal block and tighten the screws.
- Reattach the plastic housing that covers the terminal block using the two plastic housing screws.

Once the power connections have been made the OWM will boot after approximately 30 seconds.



Digital Lightwave provides a -48 VDC power supply as an option to its OWM. If you wish to use an alternative power supply it must have the following voltage: -48 VDC @ 0.7 amperes. Do not connect directly to a 120 VAC supply.

Set the OWM's IP Address



For your individual network settings, please check with your Network Administrator. The following is an example of network settings. Your actual settings are dependent on your network.

For a direct network connection, perform the following steps to set the IP address on the OWM:

- **Login to the OWM** – Using a terminal emulation package (such as HyperTerminal) login to the OWM's Command Line Interface (CLI) using “**admin**” as the default login and password.

- **Set the OWM's IP address** – To set the OWM's IP address and subnet mask, use the command “**ip**” at the OWM's command line prompt. This example will set the IP address to “10.254.254.254” and the subnet mask to the default of “255.0.0.0”:

```
% ip 10.254.254.254
```
- **Verify the IP address** – To verify that the OWM's IP address has been set, use the command “**show ip**” at the OWM's command line prompt.

```
% show ip  
ip 10.254.254.254 0xff000000  
%
```

Connect System Hardware for Network Communications

Network communication with the OWM can be achieved by connecting a PC directly to an OWM LAN port.

To connect directly to your PC or workstation:

1. Attach a CAT-5 Ethernet crossover cable to the PC Ethernet LAN port.
2. Attach the other end of the CAT-5 Ethernet crossover cable to the OWM LAN port (LAN A or LAN B).

Validate Ethernet Link

Once a valid Ethernet link is established, the Link Integrity light next to the LAN port on the OWM will light up, indicating a valid Ethernet (i.e. Data Link Layer 2) link.



The Link Integrity light does not indicate a valid or invalid IP (i.e. Network - Layer 3) link and/or associated configuration. It only indicates a valid Ethernet (i.e. Data Link, Layer 2) link.

Set the PC's IP Address

Setting the PC's IP address is necessary to establish a direct network connection.

Changes to the IP configuration are likely to be disruptive to your PC's current functionality. To re-establish current PC functionality, existing PC settings should be recorded prior to making any configuration changes.

Configure your PC with a valid static (i.e. hard coded) IP address within the same subnet and utilizing the same subnet mask as the OWM.

The following instructions will offer some guidance on where to configure the static IP address and subnet mask on your PC. Operating systems and their configurations differ between PCs, therefore, the following examples are only some of the ways to configure a static IP address. The examples shown demonstrate how to configure a PC with IP address 10.254.254.2 and subnet mask 255.0.0.0.

Windows 2000: Start >Settings >Control Panel >Network and Dial-up Connections >Local Area Connections >Properties >Internet Protocol (TCP/IP) >Properties >Use the following IP address.



You may need to reboot your PC in order for the IP address to take affect.

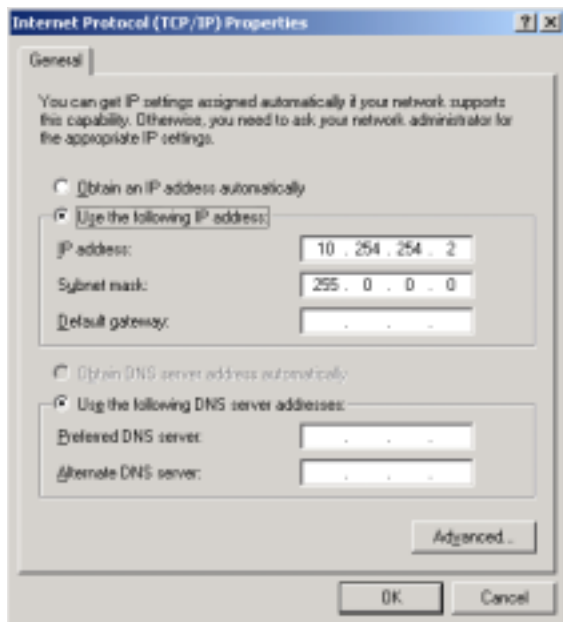

Windows 98: Start >Settings >Control Panel >Network >TCP/IP >Properties >IP Address >Specify an IP address

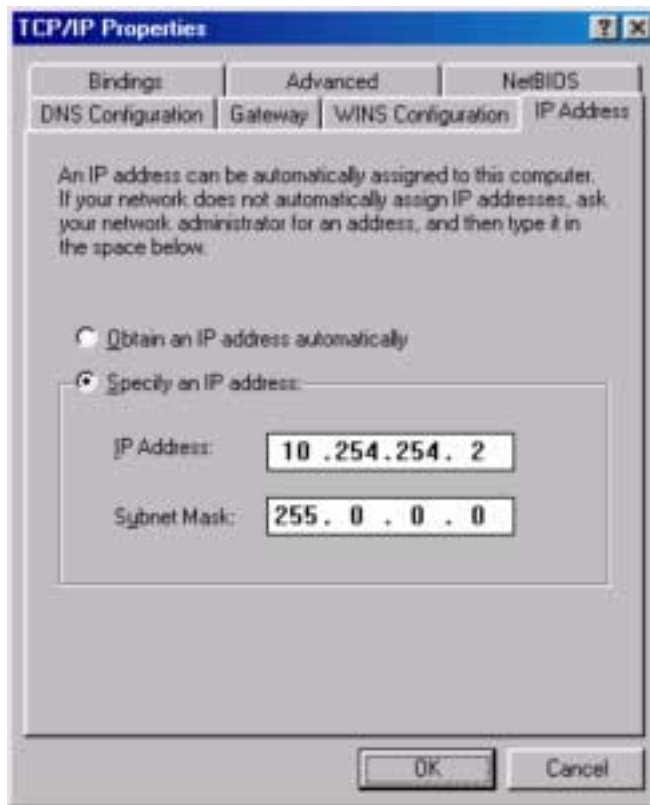

Using the “Obtain an IP address automatically” setting will fail to establish a proper IP connection between your PC and the OWM. It is intended ONLY for use with an Ethernet Connection to your organization’s LAN Environment.

Validate IP Connectivity (optional step)

The following optional steps will validate that the PC’s IP configuration has been set properly and that the PC can communicate with the OWM via IP.

1. From your PC, bring up the MS-DOS command prompt. Examples are shown for Windows 2000 and Windows 98 operating systems.

Windows 2000: Start > Programs > Accessories > Command Prompt

Windows 98: Start > Programs > MS-DOS Prompt



The Windows 98 operating system may require the user to reboot the PC.

2. Type the command “**ipconfig**”.

- Verify that the IP address and the Subnet Mask are the same as the ones that were entered previously in the section entitled “Set the OWM’s IP Address” on page 1-4.

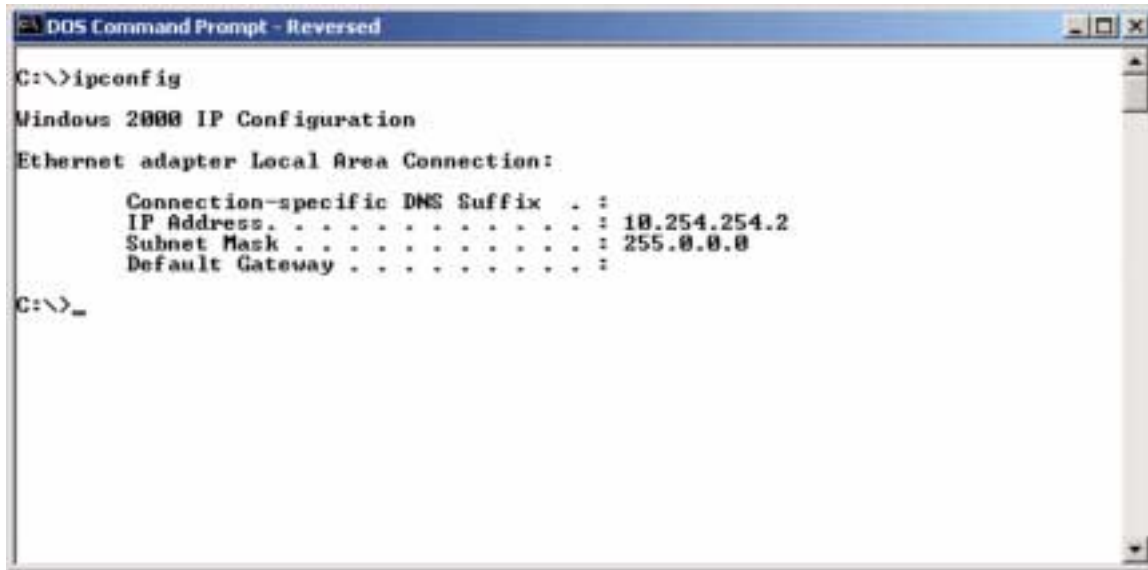

- Type the command “**ping 10.254.254.254**”.
- The PC and the OWM’s TCP/IP settings are correct if the OWM replies with something similar to the following message:

Reply from 10.254.254.254: bytes=32 time<10ms TTL=64

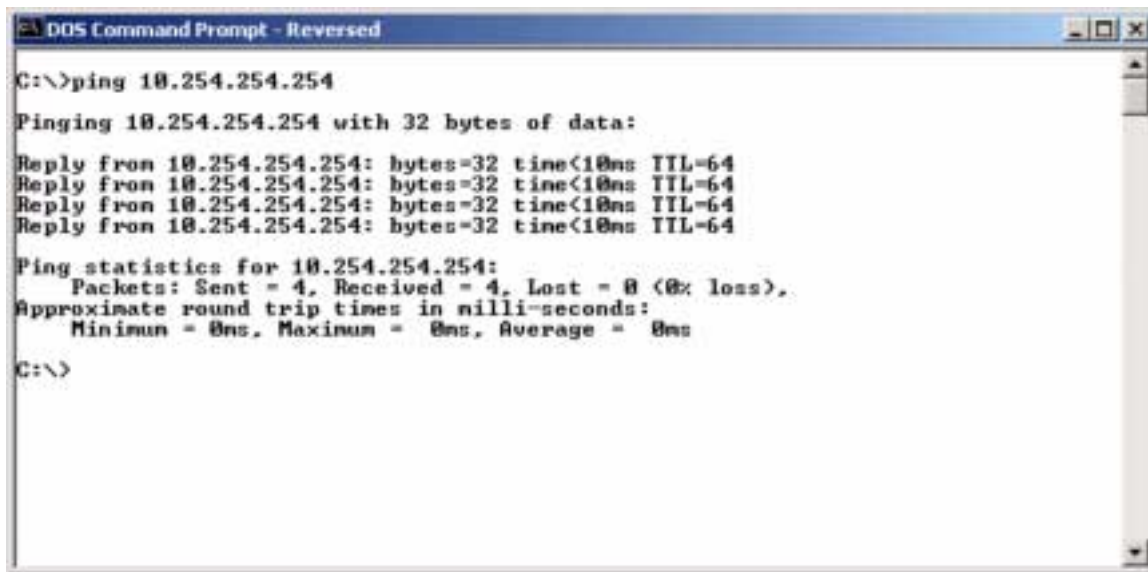

- Recheck the connectivity and PC and OWM configurations if the following message appears:
Request timed out



Contact your System Administrator if after rechecking the connectivity, the “**Request timed out**” message appears.

Install the GUI

The GUI is an application that requires installation on the PC. Use the CD provided to install this program.

Insert the Digital Lightwave OWM Java GUI Application CD into the CD ROM drive. The InstallAnywhere Program will guide you through the installation process. For a complete description of the installation process refer to The Graphical User Interface chapter of the OWM User's Guide.

Launch the GUI

To log into the GUI using the default user name and password, perform the following:

- Click Start > Programs > Digital Lightwave > Optical Wavelength Manager
- When the Login dialog box appears, enter the OWM's IP address and use "**admin**" as both the default username and password as follows:

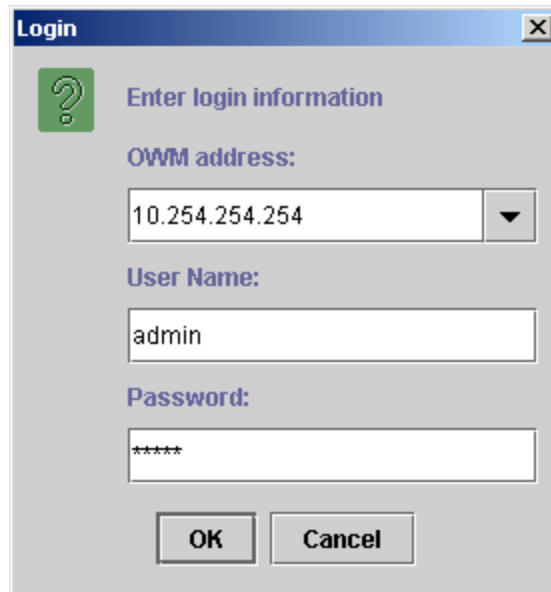

- Click OK.
- Once connected, the OWM will display the Spectrum View graph. It is important to note that the Spectrum View graph will not be accurate until the proper port tap power is defined in the "[Assign Port Tap Power](#)" section. The default tap power is 100%.

Assign Port Tap Power

After the GUI has been launched, the port tap power must be defined to coincide with the tap percentage of the splitter on the incoming fiber.



Failure to set the port tap power parameter correctly will adversely affect the power measurement accuracy of the OWM.

To assign port tap power:

- Click on **Admin** in the main menu bar to display a drop down menu.
- Click on **Manage Configuration**.
- Click on the **Admin** tab.
- Using the mouse, select the current tap power for the connected port and enter the tap power value of the incoming fiber. Tap power values are expressed as a percentage and must be ≥ 0.1 and ≤ 100.0 .
- Click **Apply**.
- Click **Save**.
- Click **Quit**.

Monitor Optical Signals in Spectrum View

Spectrum view is the default view that is displayed after logging in to the OWM. Monitoring optical signals in spectrum view is possible when optical input is provided to the OWM.

The spectrum view is a point-to-point graphical representation of the raw optical signals generated by the last activated port. Each point is plotted from power measurements made at regular intervals across the OWM measurement range.

To view signals in Spectrum View:

- Click on View in the main menu bar to display the drop down box.



FIGURE 3. View Menu

- Click on Spectrum View.



Viewing signals in Spectrum View can also be accomplished by clicking the spectrum view icon () on the toolbar.

On the Spectrum View screen, check to see if the OWM port connected to the light source (PORT 1 to PORT n) is active in the screen title. If not, perform the following sequence of instructions to activate the port:

- Click on **Commands** in the menu bar to display a drop down box.
- Click on **Port Activate** to display a drop down box.
- Click on the port that is connected to the OWM.
- Repeat the steps to *View signals in Spectrum View*.



OWM's are configured with 1, 2, 4, or 8 fiber connectors. For this temporary connection we recommend the use of "PORT 1" for single fiber applications. If you use a different port, you must configure and select the port.

Signal activity in the Spectrum View is normally displayed in yellow. If the Spectrum View screen displays signal activity in **RED** then saturation has occurred. Saturation implies that the power coming into the OWM has exceeded the OWM's power measurement range. Adjust the optical signal power coming into the OWM so that the power in any individual channel does not exceed -10 dBm (+/- 3 dB tolerance). If a broadband optical source is used at the input, the spectral power density must be held below -1 dBm/nm (+/- 3 dB tolerance).

CHAPTER 2

Configuring Devices

Introduction

This section describes how to view channel activity. Before channel activity can be viewed, a device must be defined, a set of channels must be established and the device must be activated.

This procedure can be repeated for additional devices. The maximum number of devices that can be defined is determined by the number of Monitor Input Ports on the OWM.

Define a Device

Defining a device is useful for monitoring each input fiber to the OWM. Each device may have a unique configuration of active channels, alarm settings and taps with different power splitting ratios.

Devices are defined by assigning a device name, OWM port associated with the device and a device tap power.

To Define a Device:

- Click on **Admin** in the main menu bar.
- Click on **Manage Configuration**.
- Click on the **NEW** button.
- Enter an alphanumeric device name in the **Name** field.
- Click on the down arrow in the **OWM Port** field and select the port (PORT 1 to PORT n) that is providing the light source.
- Select the value displayed in the Tap Power field and enter a tap power that reflects a percentage of bandwidth used by the OWM when the device is active. Valid tap power values must be greater than or equal to 0.1 and less than or equal to 100.0.
- Click **Update** to store the newly added information.

Configure Device Channels Automatically

- Click on the device name to be configured.
- Click on the **Auto Channels** button to have the OWM automatically generate channels for the device.
- Click on the **Peaks with Alarms** radio button on the Automatic Channel Definition dialog screen.



FIGURE 1. Automatic Channel Definition

- To automatically generate channel definitions, click **Auto Define**.

Enable Alarms

This section describes the process necessary to enable all alarms on a selected device. Channels must be defined for the device before alarms can be enabled.

- Click the **Alarms...** button to have the Device Alarm Management dialog appear.



FIGURE 2. Device Alarm Management

- Click on the **Enable All Alarms** radio button to enable alarms for the device.
- Click **OK**.
- Repeat these steps for all additional devices.

Important: to save the configuration, perform the following:

- Click **Apply** to put these changes into memory.
- Click **Save** to permanently save the configuration to a file.
- Click **Quit** to exit configuration mode.

Activate the Device

- Click on **Commands** in the main menu bar.
- Select **Device Activate** from the drop down box.
- Click on the check box of the port on which the device is configured.

View Device Channels

Once the device channels have been configured, they can easily be viewed by clicking on the Channel View icon () on the toolbar.

What to Do Next

- Once the Graphical User Interface is installed, the OWM can be operated by using the GUI or Simple Network Management Protocol (SNMP). For a complete description of SNMP refer to the OWM User's Guide.



Digital Lightwave™ Inc.
1550 Lightwave Drive
Clearwater, FL 33760
